



OPERATING AND INSTRUCTION MANUAL

08560104 - 08563501 - 08560552 - 08560152 - 08560651 - 08561051

CONTENTS

1. TECHNICAL SERVICE	7
2. INSTRUCTIONS FOR THE USER	8
2.1 Control panel	8
2.2 "BLACK MASK" control operation	8
2.3 Switching on	9
2.4 STAND-BY mode	9
2.5 DATE and TIME settings	9
2.6 Operating parameters	13
2.7 MANUAL operation	13
2.7.1 General information	13
2.7.2 PRE-HEATING setting	13
2.7.3 Cooking TIME setting	13
2.7.4 Setting cooking STEPS	14
2.7.5 Cooking TEMPERATURE setting	14
2.7.6 CORE TEMPERATURE setting	14
2.7.7 ΔT VALUE setting	14
2.7.8 HUMIDITY/STEAM setting	16
2.7.9 FAN SPEED setting	16
2.7.10 SEMI-STATIC cooking setting	16
2.7.11 DELAYED START setting	16
2.7.12 HOLDING setting	16
2.7.13 STARTING/STOPPING the cooking cycle	17
2.8 Recipe book	17
2.9 Saving a new recipe ("CHEF" recipe book)	19
2.10 Overwrite recipe from the "CHEF" recipe book	19
2.11 Deleting recipes from the "CHEF" recipe book	19
2.12 "Import/Export" with "USB flash drive" ("CHEF" recipe book)	19
2.12.1 "Import" recipes (stored programs)	19
2.12.2 "Export" recipes (stored programs)	19
2.13 COOLING setting	20
2.14 HACCP function	20
2.15 Accessories (optional)	21
2.15.1 AUTOMATIC WASHING (for set-up ovens)	21
2.16 PROOFER/HOLDING CABINET (if available)	22
3. CLEANING	22
3.1 General information	22
3.2 Manual cooking chamber cleaning	23
3.3 Semi-automatic cooking chamber cleaning	23
3.4 Automatic cooking chamber cleaning (optional)	23
3.5 Cleaning the fans	23
3.6 Cleaning the door gasket	23
3.7 Cleaning the door	24
3.8 Cleaning the external casing	24
3.9 Inactivity period	24
4. TROUBLESHOOTING	24
5. POSSIBLE ALARMS	25
6. TECHNICAL SUPPORT	27
7. DISPOSAL OF THE APPLIANCE	27
8. CONVENTIONAL WARRANTY	28
9. AVAILABILITY AND SUPPLY OF SPARE PARTS	28

GENERAL INFORMATION

It is essential for this instruction manual to be stored together with the appliance for future referencing; in the event of misplacing it, a copy must be obtained directly from the manufacturer. This information has been prepared for your safety and that of others.

Therefore, we kindly ask you to read it carefully before installing and using the appliance.

If upon reception of the goods the packaging should not be intact or should it be damaged, affix the following wording: "GOODS SUBJECT TO CHECK", with the specification of the damage and countersigned by the driver; file a written complaint with the vendor within 4 calendar days (not business days) from the date of delivery, after which no complaints shall be accepted.

For periodic maintenance checks and repairs, contact your nearest Technical Support Centre and only use original spare parts. Failure to comply with this provision shall forfeit the warranty right

The "technical data" plate is located on the side panel of the appliance.

A periodic check (at least once a year) of the appliance contributes to extending its service life and assures proper operation.

Any maintenance operation on the appliance must only be done by highly qualified personnel trained in the operations to be performed.

Before performing any maintenance on the appliance, the power supply must be disconnected (act on the safety magnetic circuit breaker located upstream of the appliance) and let it cool down.

The components that might require maintenance are all accessible by removing the left side and back of the appliance.

The inappropriate or incorrect use of the appliance shall invalidate any liability and warranty right by the Manufacturer.



BURN AND INJURY HAZARD

- The temperature of the appliance's external surfaces may exceed 60°C, only touch control elements. Burn hazard!
- Pay attention to handling food containers during and after cooking: they might be very hot. Wear appropriate protective thermal clothing to prevent burns.
- During operation, with the door open, do not remove the fan cover; do not touch the moving fans and resistors which are still hot.
- **The maximum working height, referred to the highest surface level, must be 160 centimetres from the floor. After installing the appliance apply the suitable adhesive symbol  (supplied) at a height of 160 centimetres.**
- To prevent boiling, do not use containers filled with liquids or food that liquefy with heat, in excessive amounts that cannot be easily kept under control. For this reason, only use trays that let you see inside the container. When extracting a tray containing hot liquid pay attention not to spill any liquid.
- Before removing the food from the oven after cooking with the needle shaped thermal probe (core probe), carefully extract the still hot probe from the food, taking care not to leave it hanging outside the cooking chamber.
- Do not open the door during washing operations, as chemical substances (corrosive) used for cleaning and hot fumes might escape.



ELECTRIC SHOCK HAZARD

- Before performing any cleaning on the appliance, disconnect the power supply (from the safety circuit breaker) and water supply (close the water cock). Let it cool completely.
- Any modification to the electrical system that might be required to install the appliance must be carried out by competent personnel only.
- The power supply system must be fitted with an effective earthing connection according to the regulations in force.
- In the permanent connection to the mains, a protective pole switch must be installed between the appliance and the mains with minimum opening between the contacts of overvoltage category III (4000V), sized for the load and complying with applicable regulations (automatic circuit breaker).
- If the power supply cable is damaged, it must be replaced by the manufacturer or their technical support service, or in any case by a person with similar qualifications, to prevent any risk.
- The appliance also has electrical components inside, for safety reasons it is forbidden to wash it with water or steam jets especially if aimed at the aeration vents on the metal surfaces of its outer casing.



FIRE HAZARD

- No foods containing easily flammable substances must be cooked, such as alcohol-based foods; self-combustion phenomena might occur leading to fires and explosions in the cooking chamber.
- Before using the appliance, make sure that there are no non-compliant objects (e.g. User manuals, plastic bags or other flammable objects) or detergent residues, inside the cooking chamber.
- Always keep the cooking chamber clean. Cooking liquids (fats) or food residues may ignite!

USER SAFETY

- The appliance is intended for professional use in institutional and professional kitchens and must only be used by skilled personnel who have been trained on its proper use. For safety reasons the appliance must be supervised during operation.
- The appliance is not intended to be used by children and/or persons with impaired physical, sensory or mental abilities, or who lack experience or knowledge, unless they are supervised by a person responsible for their safety, or who has been instructed on using the appliance.
- In the event of failure or poor operation, switch off the appliance, close the water supply cock, disconnect the power supply and contact an authorised Technical Support Centre.
- This appliance shall be used only for the purposes for which it was designed, meaning for all types of baking of pastries, baked goods and food: fresh and frozen; for reconditioning chilled and frozen food, for steam cooking meats, fish and vegetables.
- Any other use is considered improper.
- The noise level of the appliance in operation is less than 70 dB (A).

INFORMATION FOR THE USER

- When the appliance is used for the first time it is recommended to run an empty cycle for 40/50 minutes at a temperature of 220/230°C. In this way all unpleasant yet fully normal smells due to heating the thermal insulation enveloping the cooking chamber and the silicone used for its external sealing are dissipated.
- Avoid prolonged permanence on the steel surfaces of foods containing acidic substances (lemon juice, vinegar, salt, etc.) which cause corrosive deterioration.
- The appliance must be cleaned regularly, even daily (using automatic washing, if available), to ensure the best functionality and to extend its service life.
- If specific detergents (degreasers) are used for cleaning stainless steel, ensure they do not contain corrosive acid substances (no presence of chlorine even if diluted) or abrasive substances. Carefully follow the instructions and warnings of the detergent's manufacturer and take precautions such as using adequate rubber gloves.
- Strictly avoid using scouring pads, steel wool and scrapers that may ruin the treated surfaces.
- In order not to irreparably damage the needle shaped thermal probe (core probe), avoid using it in high temperature cooking (OVER 230°C); also avoid letting the probe cable come into direct contact with the hot metal surfaces inside the cooking chamber.

COOKING TIPS

- In placing the food in the cooking chamber, maintain a space of at least 40 mm between trays in order not to excessively obstruct air circulation.
- Do not use trays with sides higher than necessary: the sides form barriers that prevent hot air circulation.
- Preheat the oven every time before cooking to achieve top performance.
- For cooking as consistently as possible, spread the food evenly in every tray taking into account its size, layer or thickness.
- Avoid adding salt to food in the cooking chamber.
- To check correct progress of the cooking cycle use the chamber's internal lighting: avoid uselessly opening the door, which causes wastes of energy and longer cooking times.

RESIDUAL RISKS

- After baking open the door with caution, to avoid the violent outflow of heat which might cause burns.
- During oven operation pay attention to hot areas of its outer surfaces (marked on the appliance).
- Do not use the door handle to move the appliance (possible glass breakage).
- The supporting bench must be able to withstand the weight of the machine and house it correctly.
- The appliance is fitted with electrical parts and must never be washed with a water or steam jet.
- The appliance is electrically connected: disconnect the power supply before performing any type of cleaning.
- To avoid incorrect connections of the appliance, the relevant electrical/water connections are marked on the appliance by suitable identification plates.

1. TECHNICAL SERVICE

- It is essential for this instruction manual to be stored together with the appliance for future referencing; in the event of misplacing it, a copy must be obtained directly from the manufacturer.
- This information has been prepared for your safety and that of others; therefore we kindly ask you to read it carefully before installing and using the appliance.
- For periodic maintenance checks and repairs, contact your nearest Technical Support Centre and only use original spare parts. Failure to comply with this provision shall forfeit the warranty right.
- All installation and commissioning operations must exclusively be performed by technically skilled installers, according to the manufacturer's instructions and in compliance with national standards in force.
- The "technical data" plate is located on the side panel of the appliance.

Note: The inappropriate or incorrect use of the appliance and failure to comply with installation rules shall invalidate any liability by the Manufacturer.

2. INSTRUCTIONS FOR THE USER

2.1 Control panel

7" Touch Screen Display

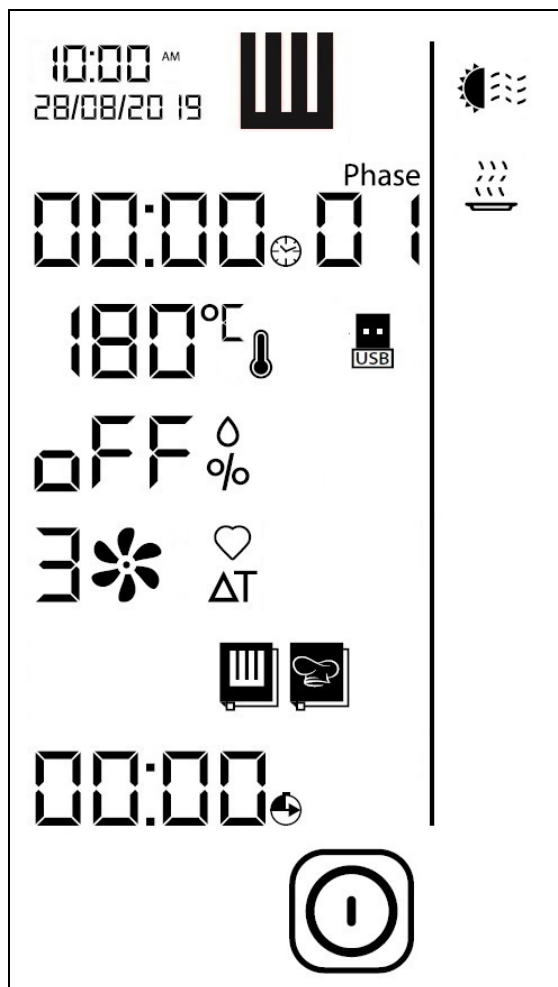

Fig.1

2.2 "BLACK MASK" control operation

The "BLACK MASK" control is activated by touching with your finger the **"symbol"** of the function and/or the **"digit"** of the parameter highlighted on the display (use only your fingers and not other tools such as knives, forks, or other objects in general). This way the desired function is activated and/or the value of the operating parameter can be set.

To facilitate the use of the control panel, only the **"symbols"** of the function and/or the **"digit"** of the operating parameter that can be activated remain highlighted (lit up).

Tapping on the **"symbol"** and/or the **"digit"** of the operating parameter emits an acoustic warning ("beep").

Tapping on the **"digit"** of the operating parameter displays the PARAMETER SCREEN with the value of the single parameter of the cooking cycle.

By touching the symbols \oplus or \ominus (nr.8 or nr.9 Fig.2) the value of the parameter increases or decreases. If you hold your finger on the same symbols, the value of the parameter increases or decreases quickly. The set value of the operating parameter is confirmed by touching the **"digit"** of the parameter or the

symbol START (nr.10 Fig.2).

Within 5 seconds of tapping on the **"digit"** of the operating parameters: "TIME", "TEMPERATURE", "HUMIDITY", "FAN SPEED", the desired value must be set; otherwise, the display automatically returns to the OVERVIEW SCREEN (displaying all the values of the cooking cycle parameters) with the value of the parameter still to be set.

2.3 Switching on

The oven is equipped with an "ON/OFF" button to electrically power the electronic control board and activate its operational functionality (Fig. 1a).

The button (A) is not directly visible as it is located under the base of the oven, in the direction of the door sensor: an identification plate (B) on the side indicates its presence.

To activate the oven function, set the button to "ON".

For the first 10 seconds the display shows the "computer codes" of the electronics controlling the oven, then the following are highlighted (in blue): the "Date and Time", logo and the symbol 

(nr.11 Fig.2). Touching the symbol  lights up (in white) the "symbols" and "digits" of the operating parameters (Fig.1).

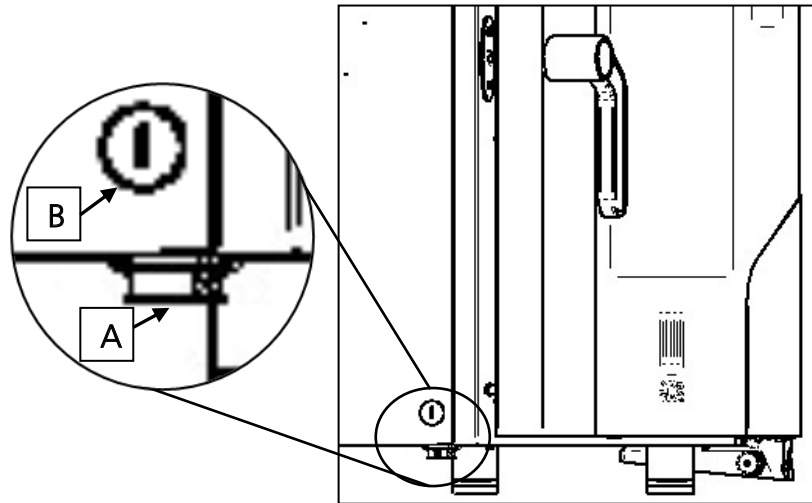





Fig. 1a

2.4 STAND-BY mode

If the oven is not being used (it is not performing any operating functions), an acoustic warning ("beep") is emitted after 10 minutes and the "STAND-BY" mode is activated automatically. In this configuration the following are highlighted on the display (in blue): the "Date and Time", the logo and the symbol 







After a further 10 minutes without operating functions, only the  symbol remains lit up on the display.

To reactivate the oven, touch the  symbol, and the "symbols" and "digits" of the operating parameters related to "start-up" will light up again on the display (Fig. 1).

If the oven is not being used, the "STAND-BY" mode can be activated at any time by tapping on the  symbol for a few seconds.

2.5 DATE and TIME settings

These settings can only be made in "STAND-BY" mode.

On the display, tap on the digits relating to "Date and Time" (nr.30 Fig.2). The bottom of the display shows the    symbols, while the upper part of the display shows the first 2 "digits" related to the Time value, which are set to be modified by touching the symbols  and . Touching the  symbol confirms the set value and the next value to be changed appears automatically.

Proceed as shown below to set the desired values relating to: "Minutes" - "Day" - "Month" - "Year".

To exit the setting mode, touch the digits relating to "Date and Time", and the display returns to "STAND-BY" mode. To activate the oven, touch the  symbol,

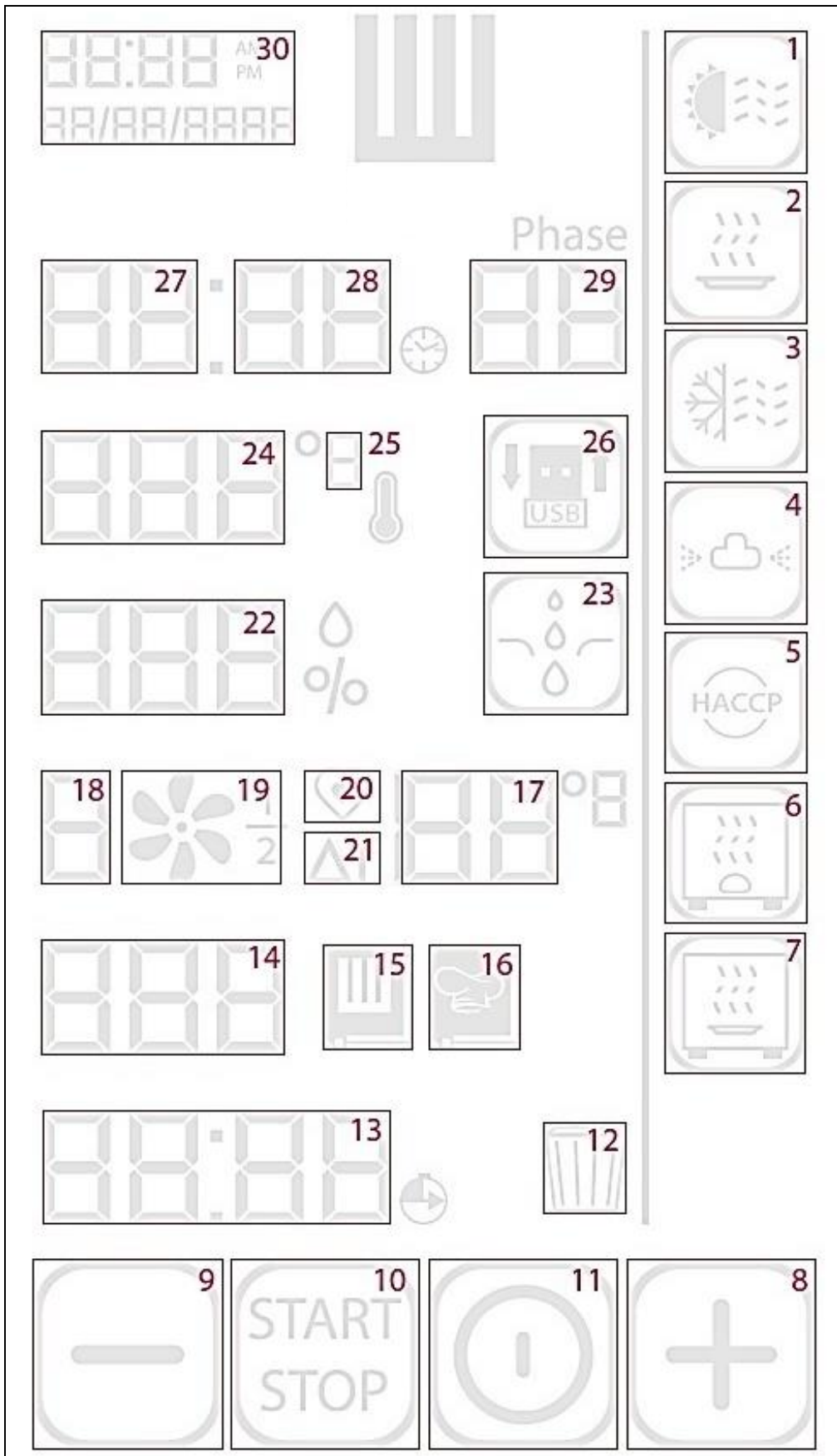







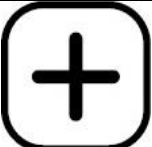
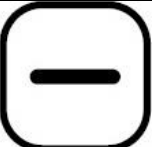

















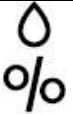

Fig. 2

Explanation of symbols/digits: (Fig.2)

1		PRE-HEATING
2		HOLDING
3		FAST COOLING
4		WASHING (optional)
5		HACCP FUNCTION
6		PROOFER (accessory)
7		HOLDING CABINET (accessory)
8		INCREASE IN VALUE
9		DECREASE IN VALUE
10		START/STOP
11		ON/OFF
12		DELETE
13		DELAYED START
14		



NUMBER OF RECIPES		
15		"MAX" RECIPE BOOK
16		"CHEF" RECIPE BOOK
17	50	CORE TEMPERATURE/ ΔT
18	3	FAN SPEED
19		SEMI-STATIC FUNCTION ACTIVATION/DISABLING
20		COOKING WITH CORE PROBE
21	ΔT	CORE PROBE AND "DELTA T" COOKING
22	oFF	%HUMIDITY/ ERROR CODE
23		MANUAL HUMIDIFICATION
24	180	TEMPERATURE ($^{\circ}C/^{\circ}F$)
25	$^{\circ}C$	$^{\circ}C / ^{\circ}F$
26		IMPORTS / EXPORTS FROM USB FLASH DRIVE
27	00:00	HOURS
28	00:00	MINUTES
29	Phase	NUMBER OF STEPS
30	00:00 00/00/0000	DATE AND TIME

2.6 Operating parameters





	COOKING TIME	from 1 minute to 11 hours and 59 minutes or "INFINITE" time (Inf)
	COOKING TEMPERATURE	30°C to 270°C (from 86°F to 518°F)
	CORE TEMPERATURE	from 01°C to 99°C (from 33°F to 210°F)
	ΔT TEMPERATURE	from 01°C to 99°C (from 33°F to 210°F)
	HUMIDITY	from OFF to 100% with 10% steps
	FAN SPEED	from 0 to 3

2.7 MANUAL operation

2.7.1 General information

- When anomalies occur during the operation of the oven that prevent the continuation of the cooking cycle or the automatic washing cycle, the display shows alarms with an acoustic warning. Alarms are highlighted (in different colours) by the letter "E" followed by the **number** that identifies the anomaly. To reset the alarm touch the  symbol: the display highlights the "STAND-BY" mode (paragraph 2.4).
- To reactivate the oven, touch the  symbol again.
- **The various types of alarms are described in the relevant paragraph 5.**

2.7.2 PRE-HEATING setting



The PRE-HEATING function can be activated or disabled by touching the  symbol (nr.1 Fig.2). When the function is active the symbol becomes . The PRE-HEATING temperature value is preset at 40°C; however, by touching the symbols  and , you can change this value from 10°C to 150°C (in 10°C steps), according to the different cooking needs.

For example, if a cooking temperature of 180°C ("step 1") and a PRE-HEATING temperature of 50°C are set, a temperature of 230°C will be reached inside the cooking chamber. An acoustic signal ("beep") warns when this temperature is reached, which is maintained as long as the oven door remains closed. Open the door (the acoustic signal is disabled) and put the product to be cooked into the oven. Close the door: the cooking cycle starts automatically.

Important

The PRE-HEATING function cannot be used together with the delayed start.
The PRE-HEATING temperature cannot exceed 270°C.

2.7.3 Cooking TIME setting

Touch the **2 "digits"** that indicate the "**Hours**" (nr.27 Fig. 2), and set the desired value by touching the symbols  and . Confirm the set value by touching the **2 "digits"** of the parameter or by touching

the  symbol. In the same way touch the **2 "digits"** that indicate the **"Minutes"** (nr.28 Fig. 2) and set the desired value.

During the cooking cycle the display alternately shows: for 4 seconds, the value of the time set for the active step, and for 4 seconds the value of the total time remaining ("countdown") for the rest of the other steps. In case "INFINITE time" is set, the display shows alternately: for 4 seconds, the **"INF"** value, and for 4 seconds the elapsed time value.

The value of the TIME parameter (**"Hours/Minutes"**) can also be changed with the cooking cycle active.

2.7.4 Setting cooking STEPS



Each cooking cycle may consist of up to 10 STEPS. The operating parameters and the desired values can be set for each step (section 2.2).

After setting the parameters and relative values for the **first step** ("Phase 01"), the following ones ("Phase 02", "Phase 03" ...), can be set by touching the **2 "digits"** indicating the **number** of the STEPS (nr.29 Fig.2), and touching the symbol .

The desired operating parameter values must be set for each step.





During cooking, the display shows alternately: for 4 seconds, the number of the active step, and for 4 seconds the maximum number of steps set.

2.7.5 Cooking TEMPERATURE setting

Touch the **3 "digits"** indicating the TEMPERATURE (nr.24 Fig.2) and set the desired value by touching the symbols  and . Confirm the set value by touching the **3 "digits"** of the parameter or touching the  symbol.

During the cooking cycle the display alternately shows: for 4 seconds, the temperature value set for the active step, and for 4 seconds the value of the temperature measured inside the cooking chamber. The value of the TEMPERATURE parameter can also be changed with the cooking cycle active.

2.7.6 CORE TEMPERATURE setting

Touch the  symbol (nr.20 Fig.2): the PARAMETER SCREEN appears with the temperature value preset at 50°C. Touch the symbols  and  to set the different desired value (nr.17 Fig.2). Confirm the set value by tapping on the  symbol.





During cooking, the display shows alternately: for 4 seconds, the value of the "core temperature" set for the active step, and for 4 seconds the value of the measured "core" temperature of the food being cooked.



The value of the CORE TEMPERATURE parameter can also be changed with the cooking cycle active.

Warning

The CORE TEMPERATURE parameter value once confirmed excludes the TIME parameter.

2.7.7 ΔT VALUE setting

Touch the ΔT symbol (nr.21 Fig.2): the PARAMETER SCREEN appears with the symbol ΔT and the preset temperature value at 50°C. Touching the symbols  and  set the different desired value (nr.17 Fig.2). Confirm the set value by tapping on the  symbol. Below is the PARAMETER SCREEN with the 

symbol and the "core temperature" value preset at 50°C. Touch the symbols  and  set the different desired value (nr.17 Fig.2). Confirm the set value by tapping on the  symbol. During cooking, the display shows the value of the measured "core" temperature of the food being cooked.

The display can show for 5 seconds the value set for "core temperature" or the value set for ΔT : by touching the  symbol or the ΔT symbol respectively.

The ΔT parameters and CORE TEMPERATURE values can also be changed with the cooking cycle active.

Warning

The ΔT parameters and CORE TEMPERATURE values, once confirmed, exclude the cooking TIME and TEMPERATURE parameters.



INSIGHTS:

• COOKING WITH CORE PROBE

There are two parameters to be set to cook with core probe: **core temperature** and **cooking temperature**. The cooking time is no longer a control parameter and so does not appear on the "overview screen".

If the cooking cycle consists of a single step, the oven works until the temperature detected by the core probe is reached inside the food. If the cooking cycle consists of several steps and core probe cooking is enabled in one of them, once the temperature detected by the core probe is reached, the oven continues to work switching to the next step.

If, during a cooking cycle with needle shaped thermal probe (core probe) the probe is not properly connected, the display shows an error with corresponding sound alarm.

IMPORTANT

The needle shaped thermal probe must be inserted inside the food, in the thickest area, avoiding contact with any bones.

If a cooking cycle with core probe is enabled, the needle shaped thermal probe must already be connected to the specific socket on the bottom of the oven; otherwise, the display will show the corresponding alarm.

With the door closed, the needle shaped thermal probe cable must pass between the door gasket (bottom area) and the door itself.

• COOKING WITH " ΔT " TEMPERATURE



There are two parameters to be set to cook with " ΔT " temperature: the **core temperature** and " **ΔT temperature**". The cooking time is no longer a control parameter and so does not appear on the "overview screen".

The " ΔT " temperature parameter makes it possible to maintain constant, throughout the cooking step, the difference between the temperature inside the food (temperature detected by the needle shaped thermal probe) and the temperature inside the cooking chamber (cooking temperature). In this way the value of the temperature in the cooking chamber becomes the sum of the temperature inside the food and the set " ΔT " temperature. In practical terms there is a slow increase of the temperature in the cooking chamber: the food undergoes a prolonged and delicate cooking process.



If the cooking cycle consists of a single step, the oven works until the temperature detected by the core probe is reached inside the food. If the cooking cycle consists of several steps and cooking with " ΔT " temperature is enabled in one of them, once the temperature detected by the core probe is reached, the oven continues to work switching to the next step.

If, during a cooking cycle with " ΔT " temperature and needle shaped thermal probe (core probe) the probe is not properly connected, the display shows an error with corresponding sound alarm.



2.7.8 HUMIDITY/STEAM setting

Touch **"OFF"/"digits"** (nr.22 Fig.2) and set the desired value by touching the symbols  and . Confirm the set value by adjusting the **"digits"** of the parameter or touching the  symbol. The value of the HUMIDITY/STEAM parameter can also be changed with the cooking cycle active.

2.7.9 FAN SPEED setting



Touch the **digit "3"** (nr.18 Fig.2) and set the desired value by touching the symbols  and . Confirm the set value by touching the **"digit"** of the parameter or by touching the  symbol. **Setting the value "0" activates the "STOP MOTORS" function:** the motors (fans) are blocked, the heating elements and the humidity/steam regulation are disabled. For this reason the function, suitably inserted within a program, may be used as a pause during the cycle itself (leavening the food inside the cooking chamber). The value of the FAN SPEED parameter can also be changed with the cooking cycle active.

2.7.10 SEMI-STATIC cooking setting



Touch the  symbol (nr.19 Fig.2): the active function is shown on the display by the  symbol that systematically disappears and reappears every two seconds; while the value of the relative set speed remains "fixed" and can also be modified during the cooking cycle. The SEMI -STATIC cooking parameter can also be disabled with the cooking cycle active.

"Semi-static" cooking is a mode that allows the motors (fans) to be activated only when the heating elements are operating. The fans are activated for a few seconds, in order to evenly distribute the heat generated by the heating elements inside the cooking chamber. This reproduces a type of operation similar to that of a static oven.

2.7.11 DELAYED START setting



Touch the **2 "digits"** that indicate the **"Hours"** (nr.13 Fig. 2), and set the desired value by tapping on the symbols  and . Confirm the set value by touching the  symbol: the **2 "digits"** of the **"Minutes"** appear. Their value can be set and confirmed in the same way as the **"Hours"**.



To confirm the function, touch the  symbol: the display automatically returns to the OVERVIEW SCREEN (showing all the values of the cooking cycle parameters) with the set parameter value ("pause time").

Touch the symbol  for a few seconds to cancel the function (the cooking TIME is also cancelled if set); otherwise, touching the  symbol activates the DELAYED START and the display only shows the "countdown" of the time before the start of the cooking cycle. The "countdown" can be interrupted by touching the  symbol: the display automatically returns to the OVERVIEW SCREEN (showing all the values of the cooking cycle parameters) with the parameter value ("pause time") reset to zero.

The DELAYED START can be set for a maximum time of **23 hours 59 minutes**.

2.7.12 HOLDING setting

The HOLDING function can be activated and disabled by touching the  symbol (nr.2 Fig.2). When the function is activated (the symbol becomes ) in a multi-step cooking cycle, it becomes operational **in the last step**, and consists in maintaining a constant temperature inside the cooking chamber.

The value of this temperature can be set by touching the symbols  and , between 65°C and 100°C (in 1°C steps). During the HOLDING function you can also set a humidification value (from off to 50%).

During the HOLDING function, the oven automatically switches to SEMI -STATIC mode with the lowest fan speed ("1"). However, if the temperature in the cooking chamber is higher than the temperature set for HOLDING, the oven runs with the fans at speed "2" until the set temperature is reached, then it automatically switches to SEMI-STATIC mode.

The function is interrupted at any time by touching the  symbol.

The HOLDING function is used to keep food warm at the end of cooking, for as long as necessary.

2.7.13 STARTING/STOPPING the cooking cycle

After setting the parameters and their desired values for cooking, simply touch the  symbol to start the cycle.

Before activating a cooking cycle with one or more steps, all the values of the set operating parameters can be cancelled by touching the symbol  (nr.12 Fig.2) for a few seconds: the display shows the OVERVIEW SCREEN relating to **first step** ("Phase 01") with the values of the parameters that still have to be set.

To interrupt the cooking cycle at any time, touch the  symbol.

When a cooking cycle ends (in "manual" mode or in "programmed" mode) an acoustic warning ("beep") is activated for 15 minutes, and at the same time the OVERVIEW SCREEN flashes on the display, showing the parameter values (excluding the TIME parameter) of the finished cooking cycle in green. By touching the  symbol or by opening the oven door, the display returns to the OVERVIEW SCREEN which shows all the parameter values set for the finished cooking cycle in white.

If during a cooking cycle a "blackout" occurs for less than one minute, when the power supply is restored the oven restarts automatically, and the cooking cycle starts again from the moment it was interrupted.

If, on the other hand, the "blackout" occurs for more than one minute, when the power supply is restored, the oven does not restart automatically, but the OVERVIEW SCREEN appears on the display, showing in red the values of the parameters set with the time remaining after the end of cooking. Moreover the "**4 digits**" (nr.13 Fig. 2) concerning the DELAYED START, display the error code "E18".

2.8 Recipe book

The manufacturer has included in the oven a recipe book that features recipes (programs) developed by its chefs. The chosen recipe can also be "customised" before executing it by modifying the values of the cooking parameters.











The recipes can be found inside the "**MAX**" recipe book, which can be accessed by touching the symbol  (nr.15 Fig.2): the OVERVIEW SCREEN appears displaying the values of the operating parameters of the **first stored recipe**. By touching the symbols  and  you can choose the number of the desired recipe (see table 1). Confirm the selected recipe by tapping on the  symbol, and start the cooking cycle by touching the  symbol.

TABLE 1			
1	Lasagna	24	Cod In Stew
2	Cannelloni	25	Grilled Prawns
3	Steamed Rice	26	Scallops Au Gratin
4	Rice Pilaf	27	Steamed Spinach
5	T_Bone Steak	28	Steamed Potatoes
6	Roast Beef	29	Steamed Broccoli
7	Braised Beef	30	Grilled Zucchini
8	Rack Of Lamb	31	Roast Potatoes
9	Pork Knuckle	32	Duchess Potatoes
10	Spare Ribs	33	Caponata
11	Grilled Chicken	34	Vegetable Flan
12	Breaded Chicken Supreme	35	Crepe Caramel
13	Stuffed Turkey Breast	36	Sponge Cake
14	Stewed Rabbit	37	Base For Shortcrust Tart
15	Skewers	38	Puff Pastry
16	Duck Breast	39	Croissants
17	Roasted Stuffed Quail	40	Cream Puffs
18	Steamed Lobster	41	Common Bread
19	Steamed Salmon	42	Brioche Bread
20	Steamed Octopus	43	Breadsticks
21	Steamed Mussels	44	Pizza
22	Sea Bass With Salt	45	Flat Bread
23	Baked Sea Bream		

The oven also includes a second recipe book: the **"CHEF" recipe book** in which up to **100 new recipes can be stored**. To access the recipe book, simply touch the  symbol (nr.16 Fig.2): the OVERVIEW SCREEN appears displaying the values of the operating parameters of the recipe to be set and stored in blue. After setting and storing the recipes, follow the same operating mode used to execute the recipes in the "MAX" recipe book.





2.9 Saving a new recipe ("CHEF" recipe book)

From the OVERVIEW SCREEN that displays all the values of the cooking cycle parameters in white, set the desired values for the new recipe to be stored (paragraph 2.2). Touch the  symbol: the OVERVIEW SCREEN appears displaying all the set parameter values in white. Tap on the symbols  and  select the "recipe number" of the cookbook to match the new recipe. If the OVERVIEW SCREEN displays the parameter values in white it means that there is already a stored recipe in that "recipe number". If the OVERVIEW SCREEN displays the parameter values in blue, it means that the "recipe number" is empty and can be occupied by the new recipe. The new recipe is stored by touching the  symbol for at least 5 seconds: an acoustic confirmation warning ("beep") is emitted and the OVERVIEW SCREEN displays the parameter values in white.

2.10 Overwrite recipe from the "CHEF" recipe book

You cannot overwrite a recipe, you must delete it and store it again.



2.11 Deleting recipes from the "CHEF" recipe book

Touch the  symbol: the OVERVIEW SCREEN appears displaying all the parameter values set for the **first stored recipe** in white. Tap on the symbols  and  select the "recipe number" of the recipe book you wish to delete. The recipe is deleted by touching the  symbol for at least 5 seconds: an acoustic warning ("beep") is emitted to confirm that the recipe has been deleted.

2.12 "Import/Export" with "USB flash drive" ("CHEF" recipe book)

Through the "USB port" present in the lower hinge of the door, it is possible to "Import" new recipes into the "CHEF recipe book", or "Export" the recipes from the same recipe book containing them, using a "USB flash drive".







2.12.1 "Import" recipes (stored programs)

After connecting the "USB flash drive" (with the new recipes) to the relative "USB port", touch the  symbol (nr.26 Fig.2) for at least 2 seconds: you will hear an acoustic warning ("beep") confirming the successful "import" (the symbol becomes ) of all the new recipes within the "CHEF" recipe book, in the first "recipe numbers" free from stored programs (recipes).

Important

If the "USB flash drive" is not connected or detected, the  symbol does not appear.



2.12.2 "Export" recipes (stored programs)

After connecting the "USB flash drive" ("empty") to its "USB port", tap on the symbols  and ; select from the "CHEF" recipe book the "recipe number" you wish to export to the "USB flash drive". It is also possible to export all the recipes in the recipe book at the same time: touch the symbols  and  until the word "ALL" appears instead of the "3 digits" that make up the "recipe number". In both cases to confirm the successful "export" (the symbol becomes ) touch the  symbol for at least 5 seconds: you will hear the acoustic confirmation warning ("beep").

Important

If the "USB flash drive" is not connected or detected, the  symbol does not appear.

2.13 COOLING setting

The COOLING function can be activated by touching the  symbol (nr.3 Fig.2) and the symbol , opening the oven door after finishing a cooking cycle. During cooling (the symbol becomes ) the "3 digits" that on the display indicate the temperature parameter, show in real time the value inside the cooking chamber.

The COOLING function can only be activated (the  symbol appears on the display) when the temperature is at least 50°C inside the cooking chamber.

The function may be disabled at any time by touching the  symbol; otherwise, it is disabled automatically when the temperature inside the cooking chamber reaches 40°C.

Warning

During operation, with the door open, do not remove the fan cover; do not touch the moving fans and resistors which are still hot.

2.14 HACCP function

The purpose of the HACCP function is to record the operational data of the cooking cycles performed, constantly monitoring their progress.

The HACCP data is recorded in a "USB flash drive" that must be connected to the "USB port" of the oven: the  symbol (nr.5 Fig.2) appears on the display.

2.14.1 HACCP function activation

After connecting the "USB flash drive" to the "USB port" of the oven, touch the  symbol to activate the function (the symbol becomes ): the operating parameters of the cooking cycle (manual or programmed) are recorded in a "file" inside the "USB flash drive".

2.14.2 Displaying HACCP data (on PC)

To display the operating parameters of a finished cooking cycle on a PC, simply remove the "USB flash drive" from the "USB port" of the oven (the  symbol disappears from the display) and insert it into the "USB port" of the PC.

The HACCP "files" inside the "USB flash drive", can be "opened" and displayed with the same procedure used for any "file".

Important

All the data concerning the cooking cycles carried out on the same day are contained in the same HACCP "file".







If more than one cooking cycle is carried out, but on different days, they are recorded in different HACCP "files": identified by the date of the day on which the cooking cycle was carried out.

2.15 Accessories (optional)

The oven is set-up for connection to the following accessories (optional):

- AUTOMATIC WASHING
- PROOFER/HOLDING CABINET

2.15.1 AUTOMATIC WASHING (for set-up ovens)

Touch the  symbol (nr.4 Fig. 2): the display shows the PARAMETER SCREEN concerning the "number of steps" where, instead of the "2 digits", by touching the symbols  and  you can select (within 5 seconds) the desired washing program: the corresponding "washing time" is also shown. To confirm it (within 5 seconds) touch the  symbol (the symbol becomes ) and then to activate it touch the  symbol. On the display the "wash time" parameter (hours/minutes) is activated in "countdown" mode.

The following washing programs can be selected:



- L1 Eco Wash (44 minutes)
- L2 Normal Wash (1h18 minutes)
- L3 Intensive Wash (1h 52 minutes)
- L4 Rinse (11 minutes)
- CP Pump Loading (2 minutes)

When the washing program ends regularly, a 10-second acoustic warning ("beep") is emitted and the PARAMETER SCREEN flashes on the display, showing the parameters of the finished washing program in green.

If a washing program ("L1"/ "L2"/ "L3") is voluntarily interrupted by touching the  symbol, the "Rinse" program ("L4") is automatically activated and cannot be interrupted, but ends regularly. The same thing happens in the event of a "blackout" during the washing cycle, when power is restored to the oven, it automatically performs the rinsing cycle.

The "Pump Loading" ("CP") program once activated cannot be interrupted and ends regularly.

The "Rinse" ("L4") program can be interrupted at any time by tapping on the  symbol.

- When the temperature in the cooking chamber is above 90°C, washing cannot be activated and the "E 10" alarm appears on the display in orange. To reset the alarm touch the  symbol: the display indicates the "Stand-by" mode (paragraph 2.4). To reactivate the oven, touch the  symbol.

Important

The first time you use automatic washing and every time you change the detergent tank, it is advisable to use the "CP" program. This way the air inside the peristaltic pump and the connection pipes is removed, ensuring the correct functionality of the system.

If the "CP" program is repeated 2 times in a row, a "Short rinse" program is automatically activated to remove any remaining traces of detergent.



When cleaning is completed leave the oven door slightly open.







Warnings

Do not open the oven door during washing operations, as chemical substances used for cleaning and hot fumes might escape. ***Danger of corrosion and burns!***

Before starting a cooking cycle ensure there are no detergent residues in the chamber that has just been washed. Any residues must be removed with a moist cloth suitably protecting your hands, eyes and mouth, and the cooking chamber must be thoroughly rinsed.

2.16 PROOFER/HOLDING CABINET (if available)



The  symbol and/or the  symbol only appear on the display if the PROOFER and/or HOLDING CABINET are electrically connected to the oven.

Touching the  symbol activates the PROOFER function (the symbol becomes ) , while touching the  symbol activates the HOLDING CABINET function (the symbol becomes ). Touching the symbols  and/or  disables the PROOFER and/or HOLDING CABINET function.

In both cases, the display of the oven will show the OVERVIEW SCREEN that shows all the values of the parameters of the proofing/holding cycle in purple with the value of the parameter that still has to be set.

To set the values for the operating parameters of the proofing/holding cycle, act on the display of the oven in the same way as for setting the values for the operating parameters of the cooking cycle.

2.16.1 Operating parameters

	PROOFER	HOLDING CABINET
 TIME PROOFING/HOLDING	from 1 minute to 11 hours and 59 minutes or INFINITE (InF)	
 PROOFING/HOLDING TEMPERATURE	from 30°C to 60°C (from 86°F to 140°F)	from 45°C to 85°C (from 113°F to 185°F)
 HUMIDITY	from 01 to 05	/

When a proofing/holding cycle ends, an acoustic warning ("beep") is activated for 5 minutes and at the same time OVERVIEW SCREEN flashes in purple on the display showing the parameter values (excluding the TIME parameter) of the finished cooking cycle. By touching the  symbol, the OVERVIEW SCREEN appears on the display showing in purple all the values of the parameters set for the proofing/holding cycle.

Touching the symbols  and/or  disables the PROOFER and/or HOLDING CABINET function.

3. CLEANING

3.1 General information

Before performing any cleaning on the appliance, disconnect the power supply (from the safety circuit breaker) and water supply (close the water cock). Let it cool completely.

The appliance must be cleaned at regular intervals, even daily, to assure best functionality and lengthening its life cycle.

The appliance is also equipped with electrical components. Therefore, for safety purposes, **it is forbidden to wash it with jets of water or steam.**

If specific detergents (degreasers) are used for cleaning stainless steel, ensure they do not contain corrosive acid substances (no presence of chlorine even if diluted) or abrasive substances. Carefully follow the instructions and warnings of the detergent's manufacturer and take precautions such as using adequate rubber gloves.

Strictly avoid using scouring pads, steel wool and scrapers that may ruin the treated surfaces.

Also avoid prolonged permanence on the steel surfaces of foods containing acidic substances (lemon juice, vinegar, salt, etc.) which cause corrosive deterioration.

3.2 Manual cooking chamber cleaning

For hygienic reasons it is good practice to clean the cooking chamber on a daily basis, at the end of every day the oven is used. Correct cleaning also prevents the formation of corrosive phenomena inside the chamber, as well as preventing the danger of accidental combustion due to any grease and food residues accumulated over time.

To aid cleaning remove the side grilles. The cleaning detergents must not contain abrasive substances or substances of acid/corrosive nature. In case of lack of appropriate detergents it is sufficient to clean the cooking chamber with a sponge soaked in warm soapy water or warm water and a little vinegar. Rinse with plenty of water (use the suitable shower if available) and dry well with a soft cloth. The side grilles must be cleaned separately and fitted back on. When cleaning is completed leave the oven door slightly open.

3.3 Semi-automatic cooking chamber cleaning

Spray specific degreaser for stainless steel on the internal walls of the cooking chamber, on the side grilles, on the fan covers (do not spray onto the fans through the grille) and on the internal door glass.

Let the product act for about 20 minutes with the door closed;

Switch the oven on adjusting the temperature at 70-80°C.

Run a cycle with maximum steam (100%) for about 15 minutes.

Upon completing the cycle switch off the oven, let the cooking chamber cool and rinse it with plenty of water (use the suitable shower if available).

Dry by running a heating cycle adjusting the temperature at 150 -160°C for about 10 minutes (repeat the cycle if necessary).

When cleaning is completed leave the oven door slightly open.

3.4 Automatic cooking chamber cleaning (optional)

To run one of the programs of the automatic washing system, **carefully follow the instructions in paragraph paragraph 2.15.1**, bearing in mind the following information:

- Before performing a washing cycle ensure the drain of the cooking chamber is free to prevent overflowing.
- The washing programs and the frequency with which to use them depend on the type of products baked in the oven.
- To maintain adequate hygienic levels and to prevent spoiling the stainless steel of the cooking chamber, the Manufacturers recommend performing an "L3" washing cycle ("intensive washing") at least once a day.
- In the event of caked dirt forming, it must be removed and manual cleaning must be performed.

Warning

At the end of cleaning with the automatic washing system, ensure there are no detergent residues inside the cooking chamber. Any residues must be removed and the cooking chamber must be accurately rinsed.

3.5 Cleaning the fans

The fans must be regularly cleaned with appropriate descaling products. All their parts must be thoroughly cleaned, eliminating any limescale. The fan cover must be removed to access fans. When cleaning is completed fit the cover back on operating in reverse order.

3.6 Cleaning the door gasket

For hygienic and functional reasons it is good practice to clean the door gasket at the end of every day the oven is used. It must be accurately washed with warm soapy water. It must be rinsed and dried with a soft cloth. Any scaling or food residues must be removed with special care, without using sharp metal tools that might irreparably damage the gasket.

3.7 Cleaning the door

The internal glass of the cooking chamber door may be cleaned using the same type of degreaser used for manually cleaning the cooking chamber; otherwise, a normal (non toxic) glass cleaning product may be used. A common glass detergent may be used also to clean the external door glass. In any case one may simply use warm soapy water. After rinsing dry the glass surface well with a soft cloth.

Should opaque spots form between the two glass panes, these may be removed as they are inspectable.

3.8 Cleaning the external casing

The outer steel surfaces must be cleaned with a cloth soaked in warm soapy water or mixed with a little vinegar, they must be rinsed well and dried with a soft cloth.

Should you wish to use specific products on the market, these must comply with the cleaning requirements set out in the "General information" paragraph (paragraph 3.1).

It is worth remembering that the counter supporting the appliance, or the floor surrounding the appliance area, should also be cleaned without using acid corrosive substances (e.g. muriatic acid) since the vapours released by them might corrode and deteriorate the outer steel shell and cause irreparable damage to the electrical components inside the appliance.

3.9 Inactivity period

Should the appliance not be used for a long extent of time, it is good practice to disconnect it from the power supply (act on the safety magnetic circuit breaker located upstream of the appliance) and water supply. It is recommended to clean it with care internally (cooking chamber) and externally, paying special attention to removing any salt residues which might lead to corrosion on the steel surfaces.

It is also recommended to protect the appliance with oil-based spray products (e.g. Vaseline oil) which form an effective protective film when sprayed on the surfaces.

Leave the door of the cooking chamber ajar.

Adequately covering the appliance, finally, allows it to be protected from dust.

4. TROUBLESHOOTING

Type of fault	Cause of the fault	Corrective action
Control panel totally off (The oven does not work)	Non-compliant connection to the power mains	Check the connection to the mains
	No mains voltage	Restore the power supply voltage
	Blown electronic board protection fuse (with microprocessor)	Contact a skilled technician
Cooking cycle on: the oven does not work	Door open or ajar	Close the door properly
	Damaged magnetic sensor	Contact a skilled technician
Humidity/steam cycle activated: there is no humidity/steam production in the cooking chamber	Non-compliant water mains connection	Check the connection to the water mains
	Closed stopcock	Check the cock
	Obstructed water inlet filter	Clean the filter
	Damaged water inlet solenoid valve	Contact a skilled technician
Closed door: steam escapes through the gasket	Non-compliant gasket assembly	Check gasket assembly
	Damaged gasket	Contact a skilled technician
	Loosened handle "nose"	Contact a skilled technician
The oven does not cook evenly	One of the motors is down or operates at low speed	Contact a skilled technician
	The motors do not reverse direction	Contact a skilled technician

5. POSSIBLE ALARMS

Type of alarm	Alarm description	Cause of the alarm	Effect	Corrective action
E1 (In red)	Cooking chamber temperature probe not detected	Connection interrupted between cooking chamber probe and micro power board	Impossible to start cooking	Contact a skilled technician
E2 (In orange)	Core probe not detected	Improper "plug - socket" connection of the probe to the core probe	It is not possible to activate a cooking cycle with the "core temperature" parameter	Check that the "plug-socket" connection of the core probe is correct
		Needle-shaped core probe interrupted/damaged		Contact a skilled technician
E3 (In red)	Safety thermostat on	Maximum allowable temperature in the cooking chamber exceeded	Oven operation deactivated	Contact a skilled technician
E4 (In red)	Thermal motor safety protection activated	Motor overheated	Oven operation deactivated	Contact a skilled technician
E8 (In red)	Display board overtemperature	Overtemperature above 70°C on the display board	Oven operation deactivated	Contact a skilled technician
E9 (In red)	Main micro power board overtemperature	Overtemperature on the micro power board above 70°C	Oven operation deactivated	Contact a skilled technician
E10 (In orange)	Automatic washing cycle cannot be activated	The temperature in the cooking chamber exceeds 90°C	The automatic washing cycle does not work	Cool the cooking chamber: open the door and touch the  (automatic cooling is activated).
E11 (In red)	Condensation hood not working	The hood's power cable is not connected to the mains	Oven operation disabled. If a cooking cycle is in progress, it is completed.	Check that the hood is connected properly to the mains

E 12 (In red)	Hood condensation chamber temperature probe, not working	Connection interrupted between condensation chamber temperature probe and electronic board	Oven operation disabled. If a cooking cycle is in progress, it is completed.	Contact skilled technician a
E 13 (In purple)	Proofer temperature probe not detected	Connection interrupted between proofing chamber probe and micro power board	Cannot start the proofing cycle	Contact skilled technician a
E 14 (In purple)	Holding cabinet temperature probe not detected	Connection interrupted between holding chamber probe and micro power board	Cannot start the holding cycle	Contact skilled technician a
E 15 (In orange)	The glass is up	Incorrect position of the glass	Oven operation deactivated	Push the glass down
E 16 (In red)	The glass is down	Incorrect position of the glass	Oven operation deactivated	Push the glass up
E 18 (In red)	Blackout	Mains power supply outage for over one minute	Oven operation disabled. When the power supply is restored, the display shows the screen of the cooking program currently running	Reactivate the cooking program
E20 (In red)	Micro power board not detected	The display board does not communicate with the micro power board	Upgrade the board firmware	Contact skilled technician a

6. TECHNICAL SUPPORT

Before leaving the factory this appliance has been calibrated and tested by experienced and skilled personnel in order to obtain the best operating results. Any repair or calibration must be carried out with the utmost care and attention, using only original parts.

That is why it is required to always contact the Dealer who has sold the appliance or our nearest Technical Support Centre, specifying the kind of failure and the model of the appliance you have. The parts required for adaptation to different types of gas are provided with the appliance hence supplied upon sale or delivery.

For servicing needs the user may contact Maxima Kitchen Equipment on the numbers shown on the cover, or refer to the website www.maximakitchenequipment.com.

7. DISPOSAL OF THE APPLIANCE

In accordance with Directive 2012/19/EU on the disposal of waste electrical and electronic equipment, the crossed-out wheeled bin symbol on the equipment indicates that the product was placed on the market after 13 August 2015, and that at the end of its services life it must be disposed of separately from other waste.

At the end of the appliance's service life, the user must, therefore, deliver it to the appropriate centres (recycling centres) for the separate collection of electrical and electronic waste.

All Maxima Kitchen Equipment appliances are made of recyclable metal materials (stainless steel, galvanised sheet metal, iron, copper, aluminium, etc.) which make up more than 90% of the total weight of the appliance. Before

disposing of the appliance, it is recommended to make it unusable by removing the power supply cable and removing the mechanism for closing compartments and/or openings, if any.

The separate waste collection and subsequent treatment, recovery and disposal, are conducive to the production of equipment with recycled materials and reduce the negative effects on the environment and health possibly caused by incorrect waste handling. Illegal disposal of the product by the user entails the application of administrative penalties.



8. CONVENTIONAL WARRANTY

The Maxima Kitchen Equipment product is designed for food use only and is covered by warranty according to Dutch law for Professional Customers or customers who purchase from the Dealer with a VAT number. The Maxima Kitchen Equipment product is professional and certified according to IEC EN 60335-1 and can only be sold to professional users. With the exclusion of any additional warranty, the Vendor agrees to repair, at its sole discretion, only those parts of the products that prove to be tainted by an original fault as long as, subject to forfeiture, the customer has reported the fault within 12 months from the date of purchase and reported the defect within 8 days from the date of discovery, in writing, attaching a copy of the invoice, receipt or tax receipt as proof of purchase.

Including the event in which the customer is unable to produce the invoice, receipt or tax receipt proof of purchase or the terms outlined above are not complied with, the warranty is expressly forfeited in the following cases:

- 1) Faults or breakdowns of components caused by transport.
- 2) Damage deriving from inadequate electrical, hydraulic and gas supply systems compared to that provided in the installation manual, or anomalous operation of the same.
- 3) Damage deriving from the incorrect product installation, or installation not in accordance with the installation manual and, in particular, damage due to inadequacy of the flues and drains to which the product itself is connected.
- 4) Use of the product for purposes other than its intended use, as specified and resulting from the technical documentation issued by Maxima Kitchen Equipment.
- 5) Damage due to the use of the Product not in accordance with the instructions in the use and maintenance manual.
- 6) Tampering with the product.
- 7) Product adjustment, maintenance and repair interventions carried out by unqualified personnel.
- 8) Use of non-original spare parts or not authorised by Maxima Kitchen Equipment.
- 9) Damage or defects caused by negligent and/or imprudent use of the product, or in contrast with the instructions prescribed by the use and maintenance manual.
- 10) Damage caused by fire or other natural events and, in any case, by fortuitous events or any other cause beyond the manufacturer's control.
- 11) Damage to components subject to normal wear that require to be periodically replaced.

Also excluded from the warranty: painted or enamelled parts, knobs, handles, mobile or removal plastic parts, light bulbs, glass parts, gaskets, electronic parts and any accessory parts and transport from the consumers, final user and/or purchases location to Maxima Kitchen Equipment and vice versa. Replacement costs of the oven and relative installation expenses are also excluded from the warranty. The warranty does not cover Products purchased as used or from third parties who are not connected to or authorised by Maxima Kitchen Equipment shall not be held liable for damage, either direct or indirect, caused by a product fault or as the result of the forced suspension of operation.

Repairs under warranty do not result in the extension or renewal of coverage.

Components replaced under warranty are, in turn, covered by a 6-month warranty from the shipping date, certified by the transport document issued by Maxima Kitchen Equipment.

No-one is authorised to change the warranty terms and conditions or to issue others, neither verbal nor written.

9. AVAILABILITY AND SUPPLY OF SPARE PARTS

Maxima Kitchen Equipment keeps and ensures the availability of spare parts for a maximum of 12 months from the date of sale of the finished product to the dealer. Availability cannot be guaranteed after said period.



WWW.MAXIMAHOLLAND.COM

INFO@MAXIMAHOLLAND.COM

+31 (0) 297 253 969

SHOWROOM:

NIJVERHEIDSWEG 19F

3641 RP MIJDRECHT

THE NETHERLANDS

**OFFICE, TECHNICAL SERVICE
DEPARTMENT & SPAREPART**

WAREHOUSE:

NIJVERHEIDSWEG 23A/23C

3641 RP MIJDRECHT

THE NETHERLANDS