

12/2018

# Mod: DFV-511/PTS

Production code: E15 RDT-105E DR 12DI 25



**Diamond**  
catering equipment

# EN CONVECTION OVENS - INSTRUCTIONS FOR USE AND MAINTENANCE

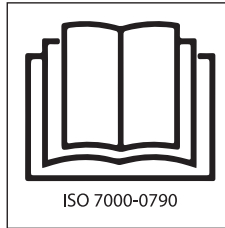

<b>RDT-105E</b>
<b>RDT-110E</b>
<b>RDT-115E</b>

<b>NG-DT-004EW</b>	<b>PDT-004G</b>
<b>NG-DT-005EW</b>	<b>PDT-005G</b>
<b>NG-DT-006EW</b>	<b>PDT-006G</b>
<b>NG-DT-007EW</b>	<b>PDT-007G</b>
<b>NG-DT-010EW</b>	<b>PDT-010G</b>
<b>NG-DT-012EW</b>	<b>PDT-012G</b>
<b>NG-DT-004G</b>	<b>CDT-107E</b>
<b>NG-DT-005G</b>	<b>CDT-111E</b>
<b>NG-DT-006G</b>	<b>CDT-207E</b>
<b>NG-DT-007G</b>	<b>CDT-211E</b>
<b>NG-DT-010G</b>	<b>CDT-120E</b>
<b>NG-DT-012G</b>	<b>CDT-220E</b>
<b>PDT-004E</b>	<b>CDT-107G</b>
<b>PDT-005E</b>	<b>CDT-111G</b>
<b>PDT-006E</b>	<b>CDT-207G</b>
<b>PDT-007E</b>	<b>CDT-211G</b>
<b>PDT-010E</b>	<b>CDT-120G</b>
<b>PDT-012E</b>	<b>CDT-220G</b>

<b>L105-DTE</b>	<b>L006-DTG</b>
<b>L105-DTG</b>	<b>L010-DTE</b>
<b>L107-DTE</b>	<b>L010-DTG</b>
<b>L107-DTG</b>	<b>CDT-107E</b>
<b>L112-DTE</b>	<b>CDT-107G</b>
<b>L112-DTG</b>	<b>CDT-111E</b>
<b>L604-DTE</b>	<b>CDT-111G</b>
<b>L604-DTG</b>	<b>CDT-207E</b>
<b>L606-DTE</b>	<b>CDT-207G</b>
<b>L606-DTG</b>	<b>CDT-211E</b>
<b>L610-DTE</b>	<b>CDT-211G</b>
<b>L610-DTG</b>	<b>CDT-120E</b>
<b>L004-DTE</b>	<b>CDT-120G</b>
<b>L004-DTG</b>	<b>CDT-220E</b>
<b>L006-DTE</b>	<b>CDT-220G</b>

<b>DFV-511/TS</b>
<b>DFV-1011/TS</b>
<b>DFV-1511/TS</b>

<b>22013440</b>
<b>22013444</b>
<b>22013448</b>

<b>FMEL461T</b>
<b>FMEL661T</b>
<b>FMEL1061T</b>

	<b>USE AND MAINTENANCE</b>
<b>4.0</b>	Instructions for a safe use of the oven
<b>4.0A</b>	Description of cooking cycle or cooking program
<b>4.1</b>	Starting the oven
<b>4.2</b>	Description of control panel components
<b>4.3</b>	Setting of CONVECTION mode in manual cooking
<b>4.4</b>	Setting of STEAM mode in manual cooking
<b>4.5</b>	Complementary functions
<b>4.6</b>	Starting manual cooking
<b>4.7</b>	Fast cooling
<b>5.0</b>	Automatic cooking programs
<b>5.1</b>	Starting an automatic cooking programs
<b>5.2</b>	Modification of a cooking program
<b>5.3</b>	Creation of a new cooking program
<b>5.4</b>	Elimination of a cooking program
<b>5.5</b>	Elimination of a phase of cooking program
<b>6.0</b>	Automatic washing system with tablets
<b>6.0A</b>	Automatic washing system with liquid detergent
<b>7.0</b>	Alarms
<b>7.1</b>	Serious alarms
<b>7.2</b>	Non serious alarms
<b>8.0</b>	Settings and regulations
<b>9.0</b>	Maintenance
<b>9.1</b>	What to do in the case of a breakdown and/or extended period of non use
<b>10.0</b>	Cooking tips
<b>10.1</b>	Remedies to cooking hitches

#### 4.0 INSTRUCTIONS FOR A SAFE USE OF THE OVEN

- Ensure the oven is on a stable position and safety devices installed upstream are efficient.
- Always use adequate protection gloves to introduce or pull out the trays.
- Always pay maximum attention to the floor, that due to cooking steam could be slippery.
- In order to avoid burns, never use trays or containers with liquids or fluids over a level that can be easily controlled at sight.
- Don't put trays or other kitchen tools on the oven.
- Periodically have a check with technical service and replace eventual damaged parts, that could alter the proper functioning of the oven or be a danger.
- Often clean the oven following the instructions stated in this manual.

#### MAX. FOOD LOADING

Number of trays	Max. food loading
4 x 1/1 GN	10 Kg
5 x 1/1 GN	13 Kg
6 x 1/1 GN	15 Kg
7 x 1/1 GN	18 Kg
10 x 1/1 GN	25 Kg
11 x 1/1 GN	25 Kg

Number of trays	Max. food loading
12 x 1/1 GN	30 Kg
20 x 1/1 GN	50 Kg
7 x 2/1 GN	36 Kg
11 x 2/1 GN	50 Kg
20 x 2/1 GN	100 Kg

For a correct comprehension of the terminology used in the following paragraphs, we underline that **cooking phase is the period of time in which the oven carries out one of the following cooking modes.**



**Convection hot forced air**  
(temperature range between 20 - 270°C)



**Combi mode**  
(temperature range between 20 - 270°C)



**Steam**  
(temperature range between 20 - 100°C)

The cooking phase can use following devices and automatisms:



Skewer probe to control the core temperature of the food to be cooked



Δt to control cooking chamber temperature



Cooking chamber release valve



High or low fan speed



Autoreverse

#### 4.0A DESCRIPTION OF COOKING CYCLE OR COOKING PROGRAM

##### Manual cooking cycle or program:

Food can be cooked in a single phase.

During the cooking program you can activate or deactivate the above mentioned devices and automatisms, adjust cooking chamber temperature, core probe temperature, humidification and cooking time.

##### Automatic cooking program or cycle:

Food can be cooked with more phases, and totally automatically.

During the program it's possible to temporary modify the above mentioned devices and automatisms and adjust cooking temperature, time and humidification.

**4.1 STARTING OF THE OVEN**

Switch on the water interception valves and the protection electric switch, installed upstream.



Press the ON/OFF key and wait few seconds for the lighting of the display.

**ATTENTION!** Turning the oven off through the button ON/OFF does not interrupt the power supply to the electronic boards.

If the oven is not used we advise you to switch off electric power supply using the protection switch upstream.

**4.2 DESCRIPTION OF PROGRAMMABLE CONTROL PANEL COMPONENTS**

- A** ON/OFF button to turn the oven on and off
- C** 5" touch screen display
- D** Cooking chamber temperature button
- E** Delta T function button
- F** Cooking time button
- G** Temperature core probe button
- H** Cook & Hold function button
- M** Chamber lighting button
- N** Display set button
- P** Autoreverse button
- R** Reduced ventilation button
- S** Cooking /programs starting button
- T** Fast cooling button
- V** Release valve on/off button
- Z** Program cancellation button

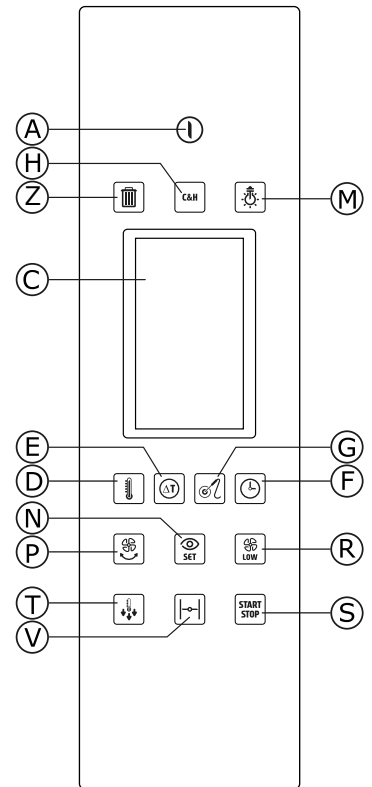

**4.3 SELECTION OF A MANUAL COOKING IN CONVECTION MODE**



To configure a manual cooking in convection mode, in the home page press the icon with the symbol on the side. The display and the buttons on the control panel visualize the following info:

3 rectangular icons indicate the parameters used to control cooking process. In the example shown on the side these parameters are the following:

- Cooking chamber temperature (the value shown indicates the real temperature inside the cooking chamber).
- Humidification percentage (this value is by default 0).
- Cooking time (this value is by default 10 minutes).

The lighted leds next to the buttons cooking chamber temperature and cooking time confirm the parameters used to manage cooking. The switched off leds of the buttons autoreverse and low speed indicate that these functions have not been activated. The switched off led of the release valve button indicates that the release valve is closed.

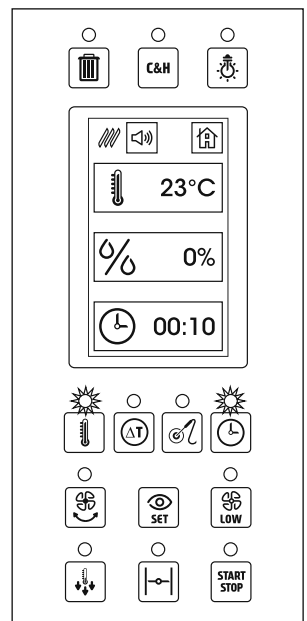

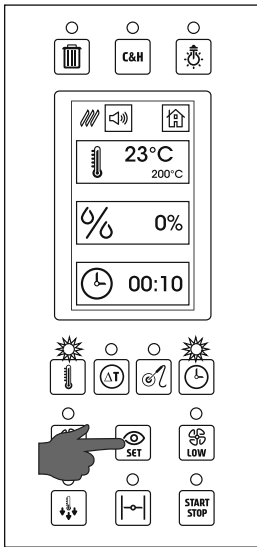

Fig. A

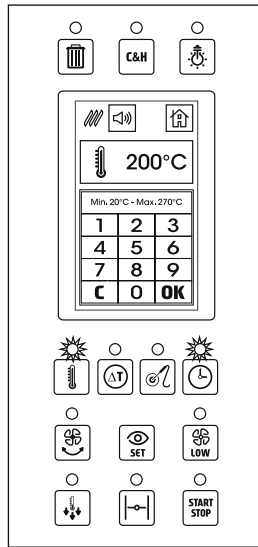

Fig. B

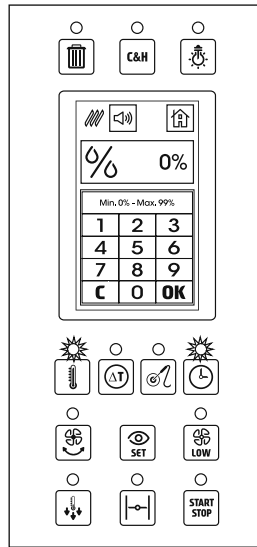

Fig. C

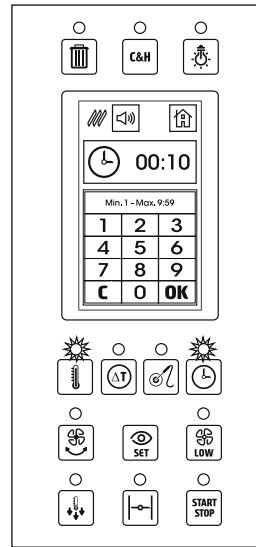

Fig. D

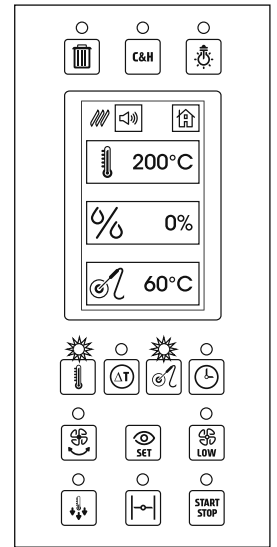

Fig. E



**Fig. A.** Pressing the set button, the display will show the selected values until the button is pressed.

In the example on the side the cooking time icon shows the real temperature (23°C) and the selected one (200°C).

The leds of the selected parameters (cooking chamber temperature and cooking time) and of the activated additional functions (autoreverse, low speed and release valve) flash until the button "see set" is pressed.



**Fig. B.** To modify the cooking chamber temperature set, press the rectangular icon with the symbol shown on the side.

The display shows the numeric keyboard to select the new temperature value.

Digit the selected value and press OK.

The selected temperature must be between 20 and 270 °C.

**NOTE:** If you have activated low speed ventilation, the temperature range is between 20 and 230 °C.



**Fig. C.** To modify the percentage of humidification of the cooking chamber, press the rectangular icon with the symbol on the side.

The display shows the numeric keypad to select the new value for humidification. Digit the selected value and press OK.

The percentage of selected humidification must be between 0 and 99%.



**Fig. D.** To modify the cooking time, press the rectangular icon with the symbol shown on the side.

The display shows the numeric keyboard to select the new cooking time.

Digit the selected value and press OK.

The selected cooking time must be between 1 minute and 20 hours.

**NOTE:** For cooking times between 1 and 59 minutes, digit the value in minutes.

For cooking times between 60 minutes and 20 hours, digit hours and minutes.

For example, for a cooking time of 1 hour and a half, digit 130 (1 hour and 30 minutes). For an unlimited functioning of the oven digit 0.



**Fig. E.** To effect a cooking process with core probe, press the button shown on the side, under the display.

The lighted led next to the cooking time button switches off and the one of the core probe switches on.

On the display, the cooking time will be replaced by the core probe.

The visualized value inside the core probe icon indicates the temperature detected by the core probe. If the core probe is not connected to the oven, this value will be visualized as ERR (error). Pressing the button "see set" inside the core probe icon, you will see both the real temperature detected by the core probe and the set value.

The default value for the core probe is 60 °C.

Selecting the management of the cooking process with the core probe, the cooking will end when the temperature detected by the skewer in the core of the product will reach the set value.

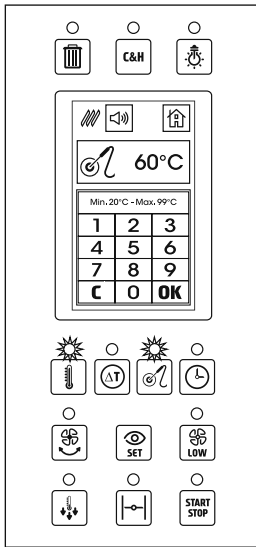

Fig. A

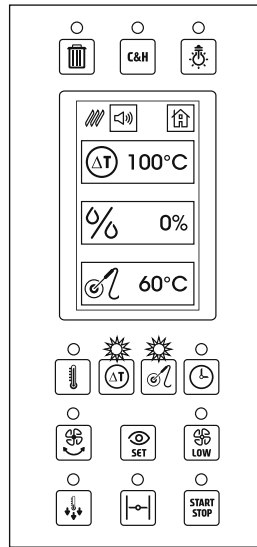

Fig. B

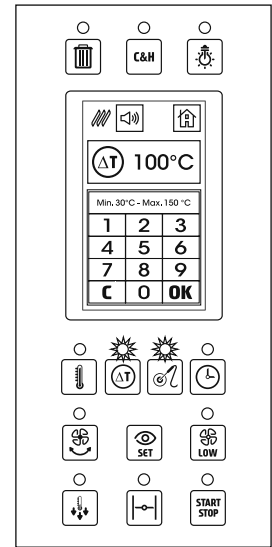

Fig. C



**Fig. A.** To modify the temperature set of the core probe, press the rectangular icon with the symbol shown on the side. The display shows the numeric keyboard to select the new value for the temperature. Digit the selected value and press OK. The selected temperature must be between 20 and 99°C.



**Fig. B.** To effect a cooking process with Delta T device, press the button shown on the side under the display. This control can be activated only if previously cooking mode with core probe has been selected. The led that was switched on next to the cooking chamber temperature button, now switches off and the led of Delta T button switches on.

In the display the cooking chamber temperature icon will be replaced by the Delta T icon. The visualized value inside Delta T icon shows the selected temperature for this type of control. The default value for Delta T function is 100 °C.



**Fig. C.** To modify the temperature set for Delta T, press the rectangular icon with the symbol on the side. The display shows the numeric keyboard to select the new value for the temperature. Digit the selected value and press OK. The selected temperature must be between 30 and 150 °C.

Setting a temperature value for Delta T, the cooking chamber temperature is directly related to the one detected by the probe. For example, if you choose for Delta T a value of 100 °C, cooking chamber temperature will always remain 100 °C higher than the temperature detected by the probe.

In this way, cooking results are much more delicate and there is less loss of weight of the food compared to traditional cooking.

This cooking method is particularly suitable to cook expensive food, in which the possibility to reduce the loss of weight can be an essential factor for the economic return of the cooking.

**VERY IMPORTANT:** Take into consideration that the use of Delta T function makes the cooking time considerably longer. Selecting a value less than 100 °C for the Delta T, the cooking time can be more than twice longer than the same cooking without Delta T control.

In the table below you can find the trend of the core probe temperature and the cooking chamber temperature in the case of a cooking in which 65 °C for the probe and 100 °C for Delta T have been selected.

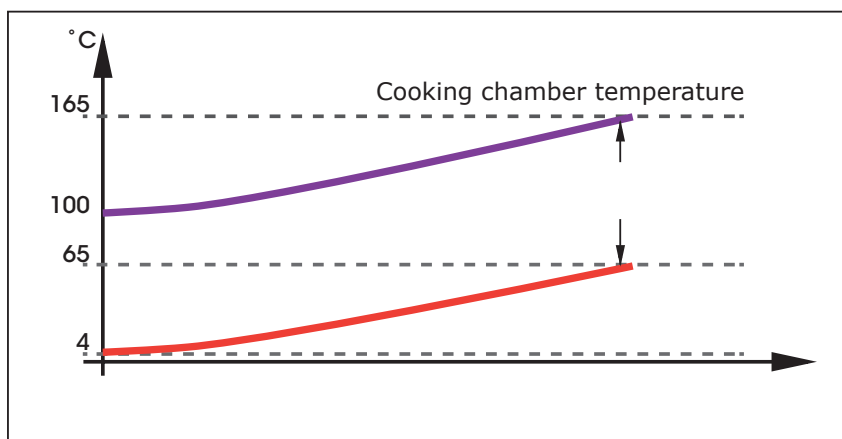

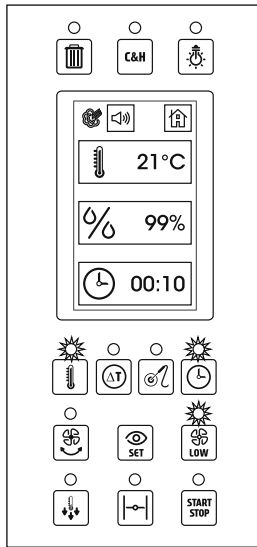

Fig. D

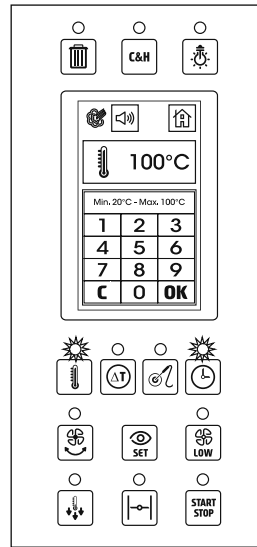

Fig. E

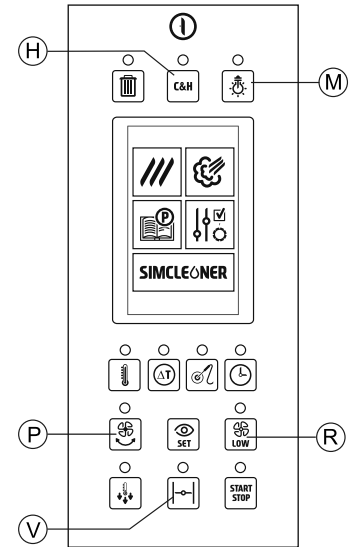

Fig. F

#### 4.4 SELECTION OF A MANUAL COOKING IN STEAM MODE



**Fig. D.** To configure a manual cooking in steam mode, in the home page press the icon with the symbol shown on the side. The display and the buttons of the control panel show the following info. 3 rectangular icons indicate the parameters used for the control of cooking process. In the example shown on the side the parameters are the following:

Cooking chamber temperature (the value indicates the real temperature).

Percentage of humidification (this value is 99% and cannot be modified).

Cooking time (this value is by default 10 minutes).

The lighted leds next to the buttons cooking chamber temperature and time confirm the parameters used to manage cooking process.

The switched off led of the autoreverse button indicates that this function has not been activated. The lighted led of low speed ventilation confirms that this function has been activated.

**NOTE:** in steam mode, by default, the oven proposes low speed.

The switched off led of the release valve indicates that the release valve is off.

**NOTE:** in steam mode, in order to maintain the maximum steam saturation inside the cooking chamber, it's not possible to open the release valve.



**Fig. E.** To modify the set of the cooking chamber temperature, press the rectangular icon with the symbol shown on the side. The display shows the numeric keyboard to set the new temperature value. Digit the selected value and press OK.

The selected temperature must be between 20 and 100 °C.

#### 4.5 ADDITIONAL FUNCTIONS

**Fig. F.** In both cooking modes (convection with humidification adjustment and steam) it's possible to activate one or more additional functions, in order to improve cooking quality. The activation of these functions is effected by pressing some buttons above and under the display. If the leds above the buttons are switched on, it means that the function has been activated. The additional functions are:



##### Low speed ventilation.

To be activated through the button R. **Note:** during the pause for speed changing, the led above the button flashes. We suggest to use low speed to keep moist food in the cooking surface when you cook with sauces and / or liquids or when there is not a dry, crispy finish.



##### Autoreverse.

To be activated through the button P. **Note:** during the pause for reversal of ventilation, the led above the button flashes. The autoreverse function reverses the sense of fan rotation each 4 minutes. Its activation improves the cooking uniformity.

Keep in mind that the necessary pauses for fan reversal can increase cooking times of about 15%.

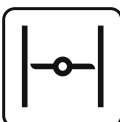

##### Release valve.

To be activated through the button V. Its opening permits the steam to go out from the cooking chamber. We recommend to open the release valve when you want to obtain dry and crispy food. It cannot be activated in steam mode, because it's necessary to keep inside the cooking chamber the biggest quantity of steam.



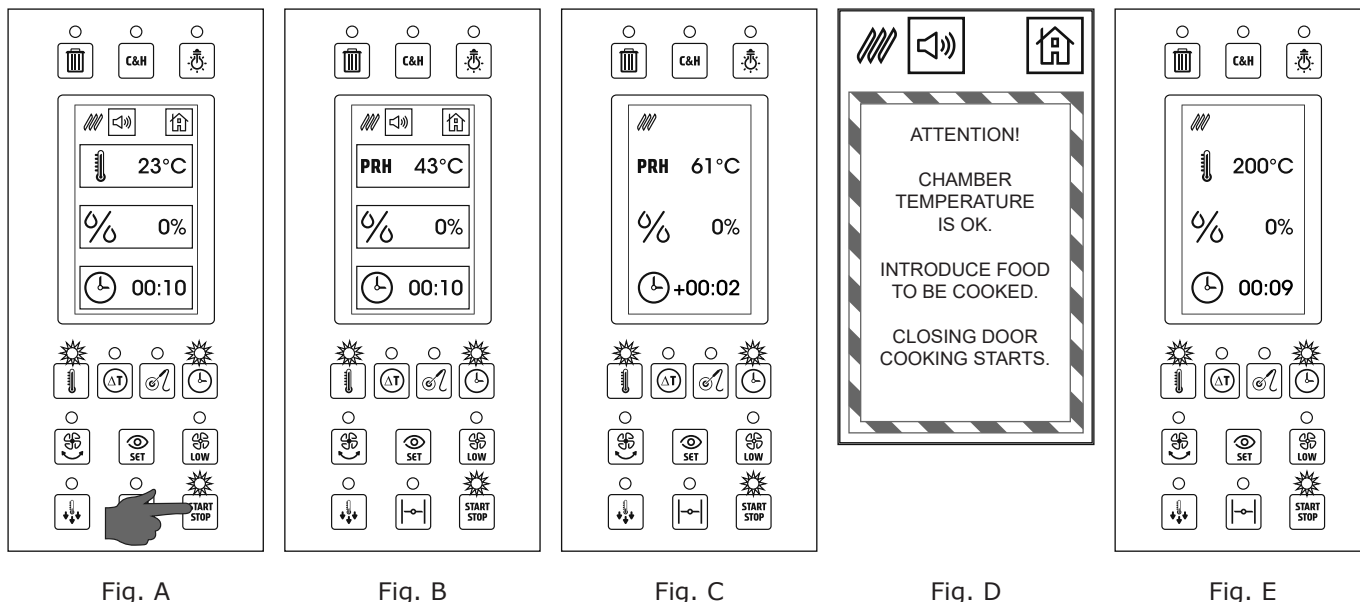

Fig. A

Fig. B

Fig. C

Fig. D

Fig. E

**Cook & Hold.**

To be activated through the button H.

The activation of this function, add at the end of the cooking cycle, an unlimited holding phase at a temperature of 50 °C.

We recommend the use of this function when it's not possible to pull out the food at the end of the cooking cycle (for ex. Cooking at night). Its activation reduces bacterial proliferation typical of slow cooling process. C&H function is not recommended when you cook using core probe.

**Cooking chamber lighting.**

To be activated through the button M.

Through this button chamber lighting turns on and off.

**4.6 STARTING A MANUAL COOKING**

**Fig. A.** After you have selected cooking parameters, it is necessary to effect pre-heating of the cooking chamber, to achieve good cooking results.

Pressing *Start* button, the oven begins the pre-heating phase.

The starting of pre-heating is confirmed by lighting of the green led of the start button.

The default pre-heating temperature is 30 °C higher than the selected cooking temperature.

In this way the decreasing of temperature when you open the oven's door will be compensated.



**Fig. B.** When pre-heating is activated, the icon that previously showed the selected cooking chamber temperature, will show the real cooking chamber temperature during pre-heating.



Pressing the button "see set", the icon will show the temperature at the end of pre-heating.

It's possible to cancel pre-heating phase by pressing *Start* button again.

It is also necessary to insert first the products to be cooked, because pressing the icon *Start* the second time, the cooking process will begin.

**Fig. C.** After 10 seconds from starting of any cooking cycle, the display will modify the way to visualize cooking parameters. The oven switches from *operative screen* to a *simplified view*.

The purpose of the simplified view is to make visible and instantly interpretable the working parameters of the oven, also at a bigger distance than the one used for operative phases.

Touching the display the oven switches to *operative screen*.



**Fig. D.** At the end of pre-heating phase you will hear an acoustic signal.

Pressing the icon on the side you will interrupt the buzzer.

At the same time, the display shows a message to introduce the food to start the cooking phase. When you close the door again, after you have inserted the tray, cooking starts.

**Fig. E.** Also in this case, after 10 seconds, the display switches to *simplified view*.



Fig. F

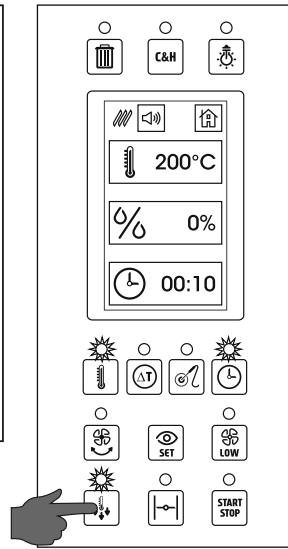

Fig. G

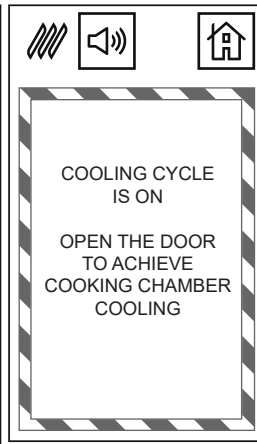

Fig. H

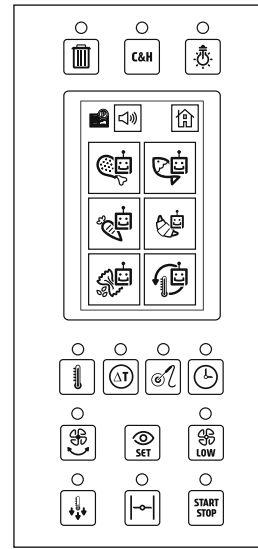

Fig. L

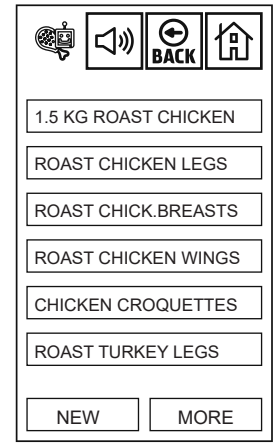

Fig. M



**Fig. F.** At the end of cooking cycle you will hear an acoustic signal. Pressing the icon on the side, the buzzer will be interrupted. At the same time, the display shows a message indicating the end of cooking cycle.

**4.7 FAST COOLING**



**Fig. G.** Pressing the button shown on the side, you start the fast cooling of the cooking chamber. The starting of cooling cycle is confirmed by the led of the corresponding button. If a cooking phase is on (the green led above the start button is also on) , it's necessary to interrupt it to start the fast cooling.

Pressing the start button, the green led will switch off, to confirm that cooking process has been interrupted. If a pre-heating phase is on, it's necessary to press the start button twice (with a first touch it switches from pre-heating to cooking, a second touch will interrupt cooking).



**Fig. H.** When you press *fast cooling* button you activate buzzer and a message warns to open the door to facilitate fast cooling. It's possible to interrupt the buzzer by pressing the corresponding icon.

**NOTE:** the cooling cycle can be activated also without opening the door, but if you open the door the temperature drops quicker. The cooling cycle stops automatically when the cooking chamber temperature reaches 45 °C but it can be interrupted at any time by pressing the correspondent button.

**NOTE:** the fast cooling is activated by default with high speed fan. It's possible to activate also reduced ventilation during cooling cycle.

**5.0 AUTOMATIC COOKING PROGRAM**



**Fig. L.** From the home page, by pressing the icon shown on the side, you can access the groups of automatic cooking programs.

The corresponding screen is the one shown on the side.

The automatic cooking programs are divided into 6 groups based on the type of food:

- Automatic cooking programs meat
- Automatic cooking programs fish
- Automatic cooking programs vegetables
- Automatic cooking programs pastry & bakery
- Automatic cooking programs rice & pasta
- Pre-cooked food regeneration programs



**Fig. M.** By pressing one among the icons corresponding to the 6 groups of automatic cooking programs, you can access the list of programs that form the selected group. The possible operations in this screen are the following:

- Select a program from the list to effect a cooking cycle or modify it.
- Scroll the list pressing the icon "more" here below on the right side.
- Add a new program pressing the icon "new" here below on the left side.
- Go back to previous screen pressing the icon *Back*.
- Go back to previous screen pressing the icon *Home*.

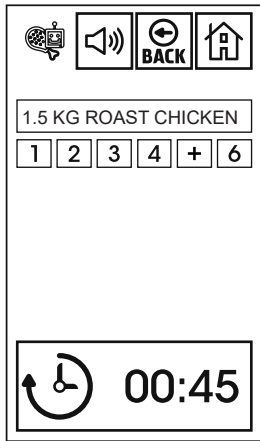

Fig. A

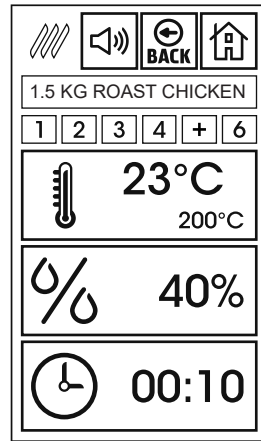

Fig. B

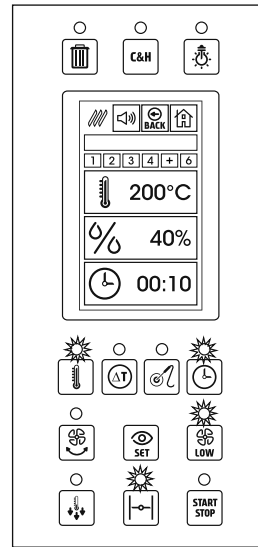

Fig. C

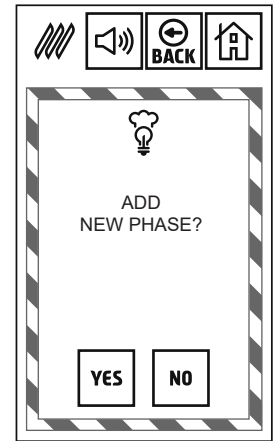

Fig. D

**Fig. A.** Select a program from the list, the screen will visualize the info shown on the side. The info visualized in this screen are the following:

- Name of the program
  - Number of phases forming the program.  
In the example shown on the side, the program is made up of 4 phases and the corresponding buttons are light blue color.  
The "+" button indicates the first free phase and can be used to add an additional phase to the program.  
The button "6" indicates a phase which is not used.  
The total duration of a program.
- Pressing the icon Back you go back to the list of programs.  
Pressing the icon Home you go back to the Home page.

1

**Fig. B.** Pressing one among the phases that form the automatic program, the oven shows the screen shown on the side.

In this screen you can see the cooking parameters of the selected phase:

- The drawing here above on the left side indicates the cooking mode (convection or steam).
- The temperature rectangular icon shows the real temperature and on a smaller scale the set temperature for the selected phase.  
This icon could visualize the Delta T parameter if you have configured this function for the control of cooking chamber temperature.
- The rectangular icon for percentage of humidification and the corresponding set value. This value can go from 0 to 99% in convection mode and it's always 99% (not to be modified) in steam mode.
- The rectangular icon for the time and the corresponding value. This icon could visualize the core probe parameter if this function has been configured to control cooking duration.

**NOTE:** besides the cooking parameters shown by the screen, on the control panel also the leds of eventual additional functions selected, activated for the selected phase light on (reduced speed ventilation, autoreverse, and open release valve).



**Fig. C.** When you press one among the phases of the program and then the button "see set" the control panel shows the info of the upside picture.

- The rectangular icons show only the selected values.  
(the real cooking chamber temperature and eventually core probe temperature are not shown).
- The leds of the buttons for the parameters used to control cooking (in the example on the side cooking chamber temperature and time) flash.
- The leds of the buttons for the additional functions activated in the selected phase (in the example here on the side, low speed ventilation and open release valve) flash.

+

**Fig. D.** If instead of pressing one of the phases of the program, you press the first free phase ("+"), you will see a message to confirm the addition of a new phase.

The instructions to add a new phase are on paragraph 5.2.

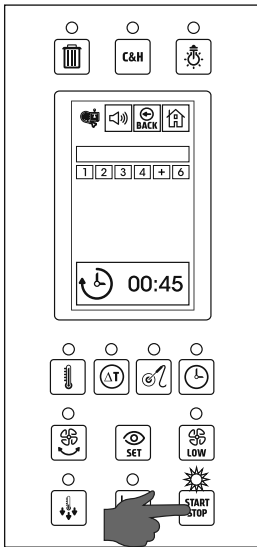

Fig. E

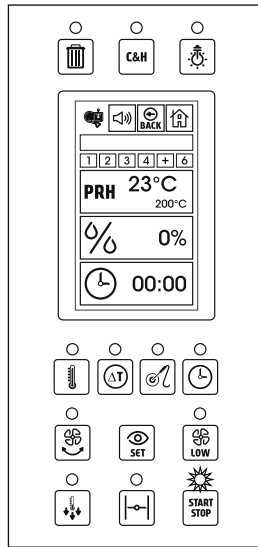

Fig. F

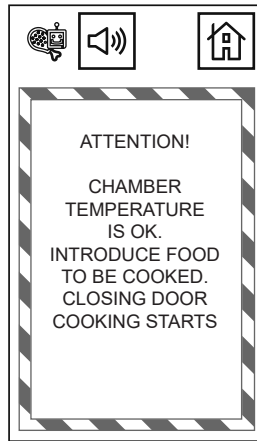

Fig. G

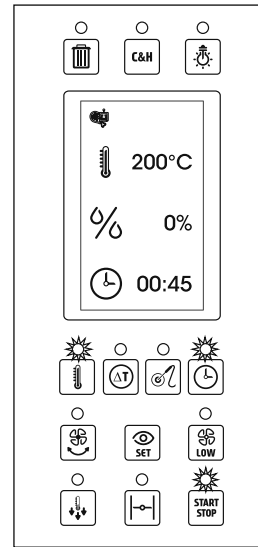

Fig. H

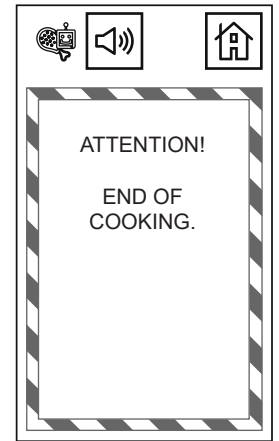

Fig. L

### 5.1 STARTING OF AN AUTOMATIC COOKING PROGRAM

**START  
STOP**

**Fig. E.** To start an automatic cooking program, you just need to select it from the list and press the start/stop button to start pre-heating of the cooking chamber.

If you don't need to modify the automatic program, you don't need to visualize one by one all the phases that form the program.

Pressing start/stop button the pre-heating of the oven starts.

The lighting of the green led next to the start/stop button confirms the starting of pre-heating.

**NOTE:** if you have selected a program where at least one among the phases foresees the use of the core probe, the screen visualizes the message:

ATTENTION!  
THIS COOKING PROCESS REQUIRES THE CORE PROBE  
ENSURE THE CORE PROBE IS CONNECTED TO THE OVEN

**PRH** **Fig. F.** When the pre-heating is activated, the icon that previously showed the set temperature for phase 1, will show the real cooking chamber temperature during pre-heating.

Pre-heating temperature will be 30°C higher than the one set for the first phase of the program.

It's possible to cancel pre-heating phase, pressing the start button again.

In this way, first you have to insert the cooking products, because the second press of start button will begin the cooking phase.

**ATTENTION:** starting a cooking phase (both manual or controlled by automatic program) without effecting pre-heating of the oven, the cooking quality will be significantly worsened. The cooking point, crispy and uniform cooking results could be less satisfactory than the expected ones.



**Fig. G.** At the end of pre-heating phase, you will hear the buzzer.

Pressing the icon here on the side, you can interrupt the buzzer.

At the same time, the display shows a message that warns you to introduce the cooking products to start cooking phase.

The door closing, after you have introduced the trays, will start cooking phase.

**Fig. H.** Also in this case, after 10 seconds, the display switches to *simplified view*.



**Fig. L.** At the end of cooking cycle, you will hear the buzzer.

Pressing the icon on the side, the buzzer will be interrupted.

At the same time, the display shows a message indicating the end of cooking process.

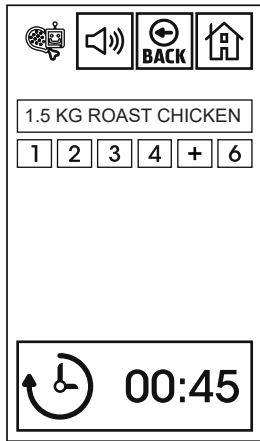

Fig. A

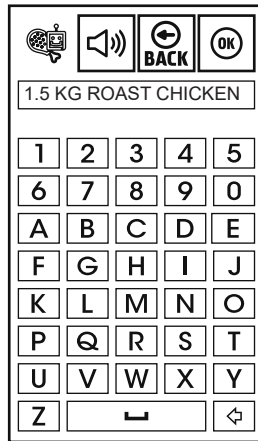

Fig. B

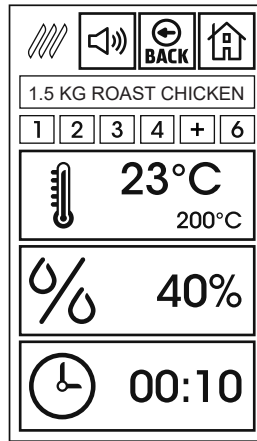

Fig. C

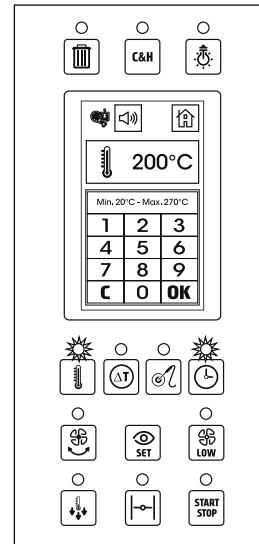

Fig. D

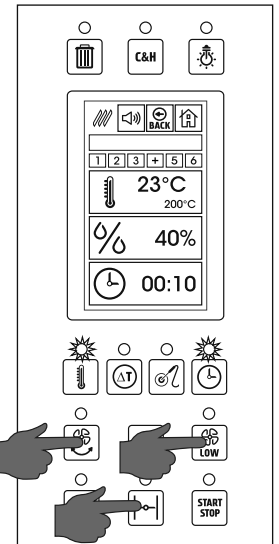

Fig. E

## 5.2 MODIFICATION OF AN AUTOMATIC COOKING PROGRAM

**Fig. A.** It's possible to modify temporarily or permanently both factory programs and also the ones created by the user.

After you have selected an automatic program, the possible modifications are the following:

- Modification of the program's name
- Parameters modification for one or more phases.
- Modification of additional functions for one or more phases.
- Add one or more phases at the end of the program (until max. 6 phases).

**Fig. B.** Pressing the name of the program, a keyboard appears on the display to enter the new name. After you have entered the new name, press the icon *OK*.

If you press *OK* without digiting anything, the name will remain the same.

Pressing the icon *Back*, the oven switches to the previous screen without doing any modification.

**Fig. C.** After you have selected a program, if you press the number corresponding to a phase of the program, you will visualize the set parameters for the selected phase.

The phases that make a program are the ones with a light blue frame.

The "+" phase is the first free after the configured ones.

The phases with grey frame are unused.

On the control panel the leds are turned on next to the buttons of parameters used for the selected phase. In the example shown, cooking chamber temperature and time have been selected.



**Fig. D.** Pressing the rectangular icon of one among the parameters, you will visualize the keyboard to modify the value. In the example here on the side you can see the modification of the cooking chamber temperature set. After you have introduced the new value, press *OK* to confirm and store it. **NOTE:** if the selected phase is in steam mode, the value for the percentage of humidification cannot be modified.

**Fig. E.** Besides the cooking parameters, it's possible to activate or deactivate one or more additional functions. The eventual additional functions activated in the selected phase are indicated by the lighted leds next to the buttons:

- Autoreverse
- Low speed ventilation
- Open release valve



**Fig. F.** If some modifications have been effected, pressing the *start/stop* button to start an automatic program, the oven visualizes the message shown on the side. Pressing the icon *YES*, the automatic program will be effected with the introduced modifications and at the end of the cooking cycle the modifications will be maintained.

Pressing the icon *NO*, the automatic program will be effected with the introduced modifications, but at the end of the cooking cycle, the oven will re-establish the previous configuration.



Pressing the icon *Back* without starting the modified program, you will be asked to save modifications.

**NOTE:** All programs, that have been modified compared with factory configuration, will be visualized in the list of programs in a rectangular frame, dark blue color instead of light blue.



Fig. F



Fig. G

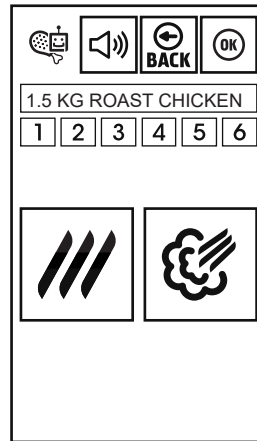

Fig. H

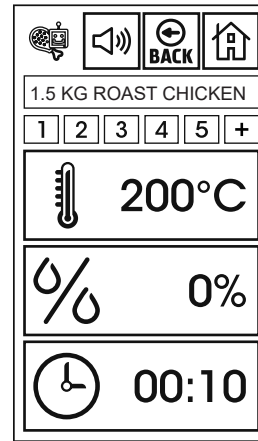

Fig. L

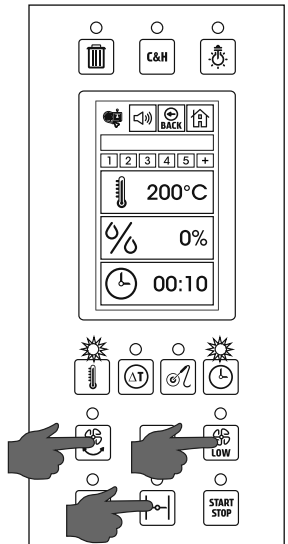

Fig. M



**Fig. G.** The button "+" shows the first free phase after the configured ones for the selected programs.

Pressing this button, you will visualize the message shown on the side where the user is asked if he wants to add a new phase to the program.

**NOTE:** if a program is made up of 6 phases, it's not possible to add more phases.

The addition of a phase could be useful for example to hold the food at a service temperature for a more or less long time.



**Fig. H.** Pressing the icon YES to add a new phase to the program, the oven proposes to choose cooking mode, that will be used to control the new phase.

To the phase previously indicated with "+", the corresponding number is now assigned.

Pressing one of the 2 icons, convection or steam, the cooking mode that will control the new phase will be selected.



**Fig. L.** Selecting for example convection mode, the oven proposes the default parameters of this mode.

It's possible to modify these parameters as previously described.

In the example shown on the side you can see the default parameters of convection mode:

- Cooking chamber temperature 200°C
- Percentage of humidification 0%
- Time 10 minutes

Besides the modification of these parameters it's possible to activate (through the buttons under the display) the control of cooking with core probe and eventually Delta T function.

**NOTE:** in the example on the side, the phase 6 that previously was unused and on a grey background, is now the new "+" phase and can be added at the end of the program.

**Fig. M.** For the new phase of the program it's possible to activate one or more additional functions:

- Autoreverse
- Low speed ventilation
- Open release valve



**BACK**

After you have completed the configuration of the new phase, press the icon *Back* to go back to the list of programs.

As for the other modifications brought to the automatic program, the user will be asked to save or not the effected modifications.

Pressing the icon *Home*, the display switches to the home page.

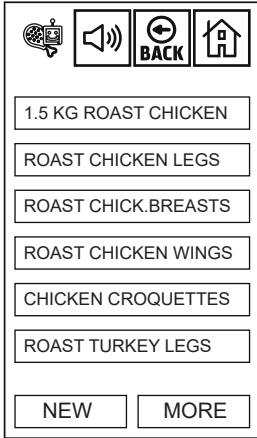

Fig. A

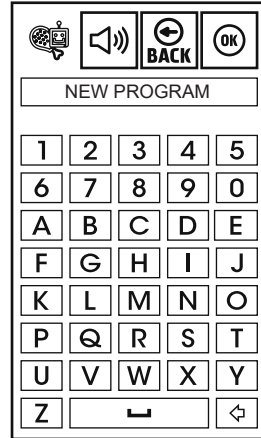

Fig. B

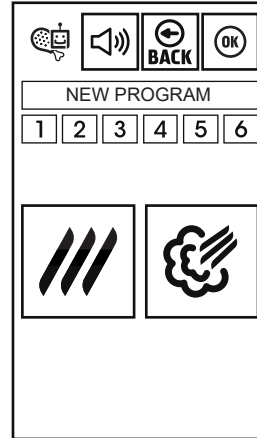

Fig. C

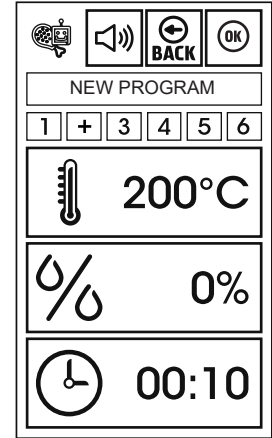

Fig. D

### 5.3 STORAGE OF A NEW AUTOMATIC COOKING PROGRAM

**Fig. A.** To store a new automatic cooking program, select among the 6 available groups of programs the one where you want to add a new program.

Press the icon NEW here below on the left side.

**Fig. B.** Using the keyboard appearing on the display, digit the name for the new program.

Press OK to confirm.

**Fig. C.** The display now visualizes the name of the new program and the 6 phases it's possible to configure.

Phase 1 has a green background to indicate that the user is configuring it.

The other phases are at the moment on a grey background (unused).

To go on, select the mode which will control the first phase of the program (convection or steam).

**Fig. D.** After you have selected the mode, the display will propose the default values.

It's possible to modify these parameters as described in the previous paragraphs.

In the same way it's possible to select the core probe and eventually Delta T function to control the phase.

You can activate the available additional functions (autoreverse, reduced ventilation, open release valve).

If you have already configured at least 1 phase, the icon OK can be activated to store the new program.

After you have configured the parameters of the first phase, press "+" to add a new phase and proceed with a new configuration.

After you have configured the foreseen phases for the new program, press the icon OK to store them.

The new program will be added at the end of the list for the stored programs.



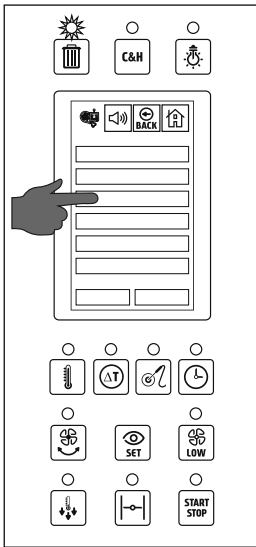

Fig. E

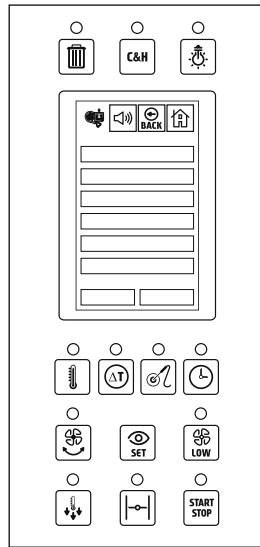

Fig. F

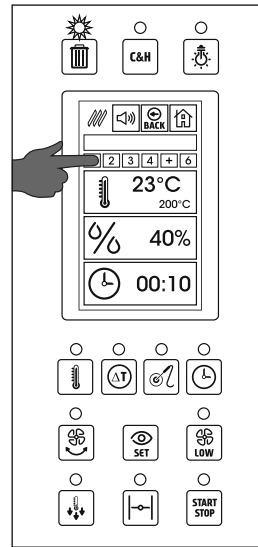

Fig. G

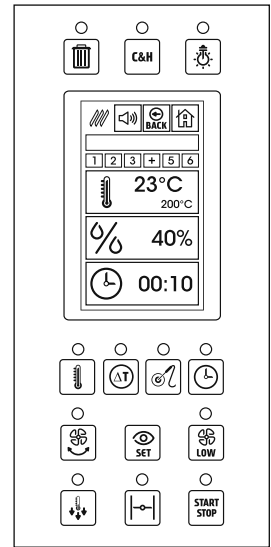

Fig. H

#### 5.4 CANCELLATION OF AN AUTOMATIC COOKING PROGRAM

**Fig. E.** To definitively cancel an automatic cooking program (both a factory one or the one created by the user), scroll the list of the programs using the icon "more" until the program to be eliminated will appear on the display.

Press the program to be cancelled and keep it pressed until the background turns red color.

When the background with the name of the program turns red color, the red led of the button "cancellation" above on the left hand side switches on.



**Fig. F.** Pressing the button "cancellation" shown on the side, the program will be definitively cancelled from the list.

**ATTENTION!** This operation is not reversible.

To restore the cancelled default programs, you need to upload the factory recipes using USB connection (see paragraph 8.0).

#### 5.5 CANCELLATION OF A PHASE OF AN AUTOMATIC PROGRAM

**Fig. G.** It's possible to cancel one or more phases of an automatic cooking program.

This operation can be useful for example for a program where the first phase is used to seal the product but the chef prefers to effect this operation on the fire.

If you eliminate the first phase, it will be possible to do sealing on the fire and then complete cooking using the program without the first phase.

To cancel a phase of a program, press the selected phase and keep it pressed until the background turns red color.

At the same time the red led of the button "cancellation" above on the left hand side switches on.



**Fig. H.** Pressing the cancellation button shown on the side, the selected phase will be definitively removed from the list.

**ATTENTION!** This operation is not reversible.



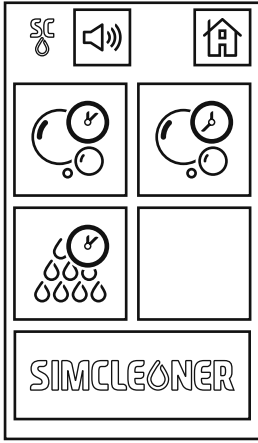

Fig. A



Fig. B

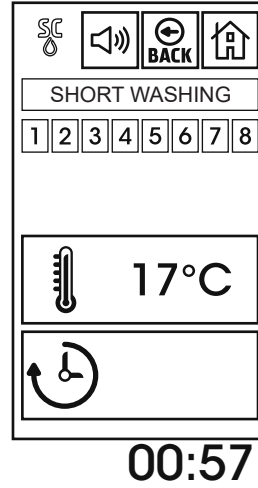

Fig. C

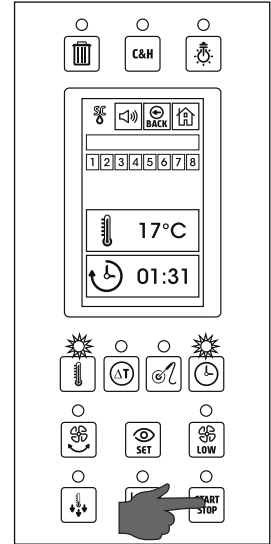

Fig. D

**6.0 AUTOMATIC WASHING SYSTEM WITH TABLETS**



**Fig. A.** To access automatic washing programs, from the home page, press the icon shown on the side.

The display shows the available programs.



**Short washing cycle.**

Particularly suitable when the oven is washed very often or when it's not so dirty.



**Long washing cycle.**

Particularly suitable when the oven is not washed very often or when it is very dirty (in this case, more than one washing cycle could be necessary).



**Rinsing**

This program effects a rinsing of the cooking chamber and doesn't requires detergent.



**Fig. B.** Selecting for example the *short washing program*, on the display you will see the measuring of detergent to use.

**ATTENTION!**

Exclusively use the products created by the manufacturer to clean the ovens equipped with Simcleaner washing system:

- Detergent in tabs **DETABINOX®**

**The manufacturer does not accept any complaint for oxydations and exfoliations of stainless steel , if the oven has been washed with different products in comparison with the ones indicated in this manual.**

**Fig. C.** After you have introduced in the suitable receptacle the detergent tabs, according to the measuring shown by the oven, press the pop -up message to know the duration of the selected cycle.

In the example shown on the side, the selected program has a duration of 57 minutes.

**NOTE:** the duration of the washing programs depends on the model and dimensions of the oven, and also on the measuring of tabs to be used.

During execution of a washing cycle, the time icon visualizes the missing time to complete the cycle.



**Fig. D.** Pressing the *Start/Stop* button, the washing cycle begins.

**NOTE:** during the first minutes of the washing cycles, the oven heats the cooking chamber in steam mode, to remove the grease from the surfaces.

The water will start coming out from the washing arm only after few minutes.



Fig. E

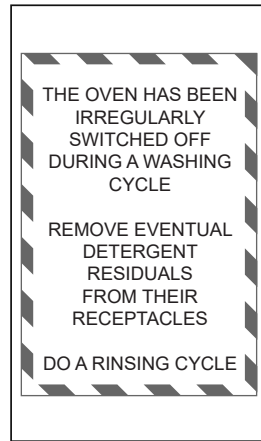

Fig. F



Fig. G

**Fig. G.** In all ovens of this series, the containers for the detergent and sparkling aid are located above the oven.

**ATTENTION!** After a cooking process, the oven front panel and the top panel could be very hot. It's necessary to be very careful to avoid any contact with very hot surfaces and we suggest you to use protection gloves.

Unscrew the cap of detergent container (this operation can be carried out simply by hands), introduce DETABINOX® detergent tabs, following the instructions on the screen.

Screw the caps again and close the oven's door.

**THE USE OF SPANNERS OR PLIERS TO SCREW AND UNSCREW THE CAPS IS FORBIDDEN. TO HANDLE DETERGENT AND SPARKLING AID TABS, USE PROTECTION GLOVES AND MASK.**



**NOTE:** to facilitate the dissolution of dirt, we advise to spray the internal part of the cooking chamber with a degreasing product suitable for oven cleaning.

**VERY IMPORTANT:** to use **BRILLINOX®** sparkling aid, you need to select the *RINSING* program.

### 6.0A AUTOMATIC WASHING SYSTEM WITH LIQUID DETERGENT

In models equipped with automatic washing with liquid detergent, in the back side of the ovens supplied with automatic washing system, there are 2 small pipes for the suction of detergent and sparkling-aid.

The red color pipe must be inserted into the liquid detergent container.

The white color pipe must be inserted into the liquid sparkling-aid container.

**IMPORTANT NOTE:** ensure that the liquid detergent and sparkling-aid are specific for stainless steel cleaning.

Check frequently the level of the detergent and sparkling-aid inside their containers, in order to avoid any damage to the pump if it works in vain.

**Fig. E.** If the chamber is too hot to start a washing cycle, the oven will show a message like the one shown on the side.

The cooling cycle before the washing cycle can be effected both with open (in a shorter time) and with closed door (in a longer time).

If you open the door to make cooling cycle quicker, wait for the following message (end of cooling) to close it again.

**Fig. F.** Once the washing cycle has started, it's necessary to complete it, to avoid eventual detergent residuals can contaminate the food during the following cooking processes or damage the stainless steel surfaces, when in touch with too high temperatures.

If the oven is stopped during an automatic washing cycle, when you turn it on again the display will show a warning message shown on the side, to remind you that you need to remove eventual detergent residuals and effect a rinsing cycle before any cooking cycle.

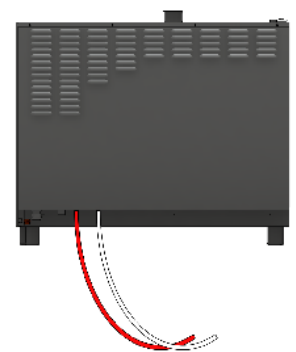

## 7.0 ALARMS

The alarms are the oven protection system. They activate automatically as a pop-up white color with white-red edge.

**Very important:** in case of an alarm, take note of the code at the bottom on the right hand side to communicate it to the technical service.

The alarms are divided in 2 groups:



### Serious alarms.

Serious alarms, marked with the symbol on side, stop all functions of the oven.





### Not serious alarms.

Not serious alarms, marked with the symbol on side, stop only specific functions of the oven.

## 7.1 SERIOUS ALARMS

Description	Code A000
It indicates an incompatibility problem between the keyboard and the software of the motherboard (usually due to the replacement of one of the two components).	 ATTENTION! CONFIGURATION ERROR IT IS NECESSARY TO UPDATE THE FIRMWARE OF THE OTHERBOARD
<b>Oven functioning</b>	
The oven is locked. Any action of the operator is possible.	
<b>Resetting</b>	
The oven turns to be operative and a correct communication between the 2 components is established again.	
<b>Suggestions for the operator</b>	
Disconnect the electric supply. Call the technical service.	
<b>Remarks for the technical service</b>	
Update the firmware of the screen and the relay board.	

Description	Code A010
There is a communication problem between the display and the motherboard that controls the different components.	 ATTENTION! NO CONNECTION BETWEEN KEYBOARD AND BASE NO POSSIBLE ACTION CALL TECHNICAL SERVICE
<b>Oven functioning</b>	
The oven is locked. Any action of the operator is possible.	
<b>Resetting</b>	
The oven turns to be operative and a correct communication between the 2 components is established again.	
<b>Suggestions for the operator</b>	
Disconnect the electric supply. Call the technical service.	
<b>Remarks for the technical service</b>	
Check the connection between the screen and the components motherboard is efficient. Check the functioning of the 2 components. <b>VERY IMPORTANT:</b> in case of replacement of one of the 2 components it's necessary to update the software and ensure its configuration corresponds to the oven model.	

Description	Code A020
Intervention of the cooking chamber safety thermostat.	 <b>ATTENTION!</b> SAFETY THERMOSTAT INTERVENTION SWITCH OFF THE OVEN IT IS NECESSARY TO RESET THE SAFETY THERMOSTAT IF THE MALFUNCTIONING DOESN'T DISAPPEAR CALL TECHNICAL SERVICE
<b>Oven functioning</b>	
If the oven is cooking it stops. It is possible to go from one screen to another one, but the cooking chamber heating is off.	
<b>Resetting</b>	
After the oven has cooled down, it is necessary to reset safety thermostat (F2), by removing the right panel of the oven.	
<b>Suggestions for the operator</b>	
Turn the oven off, check the fan rotates without any friction. Cool down the oven and try to cook again. If the problem persists, call the technical service.	
<b>Remarks for the technical service</b>	
Check the fan is clean and rotates correctly. Check the foreseen RPM of the fan. Clean carefully the sensors for the detection of cooking chamber temperature. Check the temperature on the display corresponds to the real one inside the cooking chamber. Reset the safety thermostat, by pressing the suitable button or proceed with replacement of the part.	



Description	Code A030
Intervention of motor thermal protection probe.	 <b>ATTENTION!</b> MOTOR FAN PROTECTION DEVICE INTERVENTION SWITCH OFF THE OVEN IF AFTER ONE HOUR THE MALFUNCTIONING DOESN'T DISAPPEAR CALL TECHNICAL SERVICE
<b>Oven functioning</b>	
If the oven is cooking, it stops. It's possible to move from one screen to the other one, but the rotation of the fan (and consequently the cooking chamber heating) is off.	
<b>Resetting</b>	
After the motor cooling, the oven turns to be operative.	
<b>Suggestions for the operator</b>	
Turn the oven off, check the fan rotates without any frictions, if any remove them. Check the cooling slits on the right hand side panel of the oven are not obstructed. If the anomaly persists after 1 hour or it repeats, call the technical service.	
<b>Remarks for the technical service</b>	
Check the rotation of the motor shaft is free, without any friction and that the bearings are efficient. Check the stainless steel fan is not deformed and its rotation is regular. Check tightness of motor shaft gasket in the components compartment. Effect an electric control of the motor, to find out eventual defects.	



Description	Code A040
Malfunctioning of cooking chamber temperature probe.	 <b>ATTENTION!</b> COOKING CHAMBER THERMOSTAT MALFUNCTIONING IT'S IMPOSSIBLE TO COOK WITHOUT A RELIABLE TEMPERATURE REFERENCE
<b>Oven functioning</b>	
When the oven is cooking, it suddenly stops. It's not possible to cook without a stable temperature.	
<b>Resetting</b>	
If you want the oven to be operative again, it's necessary the probe returns to work correctly.	
<b>Suggestions for the operator</b>	
Call the technical service.	
<b>Remarks for the technical service</b>	
Check probe connections. If necessary, replace cooking chamber temperature probe.	

Description	Code A090
The temperature inside electronic components compartment (on the right hand side of the oven) is too high and can damage the integrity of the components.	 <b>ATTENTION!</b> HIGH TEMPERATURE ELECTRONIC DEVICES COMPARTMENT SWITCH OFF THE OVEN IF AFTER ONE HOUR THE MALFUNCTIONING DOESN'T DISAPPEAR CALL TECHNICAL SERVICE
<b>Oven functioning</b>	
If the oven is cooking, it stops. It's not possible to keep on using the oven.	
<b>Resetting</b>	
The oven will be operative again, when the temperature will be lower than the selected value.	
<b>Suggestions for the operator</b>	
Check the ventilation holes under the control panel (next to USB and core probe connector) are not obstructed. Check the ventilation holes on the right hand side panel are not obstructed and that the air can pass through these holes. If the problem persists, call the technical service.	
<b>Remarks for the technical service</b>	
Check the functioning and the connections of the cooling fan for the components compartment. Ensure there are not hot sources next to the right hand side of the oven (we recommend a minimum distance of 50 cm). Check the ventilation holes are not obstructed by grease or dust.	

## 7.2 NOT SERIOUS ALARMS

Description	Code A210
The core probe doesn't work properly. It's not possible to use this device.	 <b>ATTENTION!</b> CORE PROBE MALFUNCTIONING DISCONNECT CORE PROBE IT IS POSSIBLE TO KEEP ON COOKING ONLY USING TIME CONTROL REPLACE CORE PROBE
<b>Oven functioning</b>	
It's possible to use the oven with time control of the cooking. It's not possible to use automatic programs including one or more phases controlled by the core probe.	
<b>Resetting</b>	
The oven can work with core probe again, when the core probe is functioning correctly again.	
<b>Suggestions for the operator</b>	
Check the core probe is properly connected to the oven. Check the cable and the skewer are integral If the problem persists call the technical service.	
<b>Remarks for the technical service</b>	
Check the functioning of the core probe (the reading of the heating element in ohm of the probe must be 1000 + room temperature). If necessary, replace the core probe.	

Description	Code A240
Lack of gas or failed ignition of the cooking chamber burner.	 <b>ATTENTION!</b> NO FLAME COOKING CHAMBER BURNER TO ATTEMPT IGNITION AGAIN PRESS "RESET GAS" ICON 
<b>Oven functioning</b>	
For security the gas valve is closed. The reset gas icon appears grey (inactivable) for a few seconds to give time for the system to complete the safety procedures.	
<b>Resetting</b>	
When the reset gas icon becomes activable it's possible to try to light the burner again by pressing the icon.	
<b>Suggestions for the operator</b>	
If the problem persists, call the technical service.	
<b>Remarks for the technical service</b>	
Check the efficiency and the integrity of the gas installation. Check the proper functioning of the electrodes and electronic control units.	

<b>Description</b>	Code A260
After three unsuccessful attempts to reset gas it is necessary to restart the oven to try the lighting process again. This operation helps the removal of any residues of gas in the burners.	 <b>ATTENTION!</b>  3 IGNITION ATTEMPTS FAILED TO ATTEMPT IGNITION SWITCH THE OVEN OFF AND ON OR CALL THE TECHNICAL SERVICE  
<b>Oven functioning</b>	
Until the oven has been restarted it is not possible to try the lighting of the burners again.	
<b>Resetting</b>	
By restarting the oven it is possible to try the lighting process again.	
<b>Suggestions for the operator</b>	
Call the technical service.	
<b>Remarks for the technical service</b>	
Check the efficiency and the integrity of the gas installation. Check the proper functioning of the electrodes and electronic control units.	

**8.0 ADJUSTMENTS**



From the home page, pressing the icon shown on the side, you access the area dedicated to adjustments and configuration of the oven.

On the screen visualized by the oven, you have 3 accesses:



**Area for manufacturer adjustments**

This area, protected by password, is reserved to the manufacturer.



**Area for installer adjustments**

This area, protected by password, permits the access to adjustments reserved to installer.



**Area for user adjustments**

This area, protected by password, permits the access to adjustments reserved to the user.



To access the adjustments for the user, digit 0 and press OK.

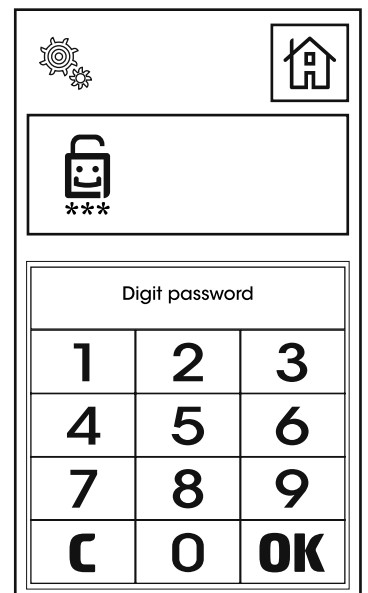
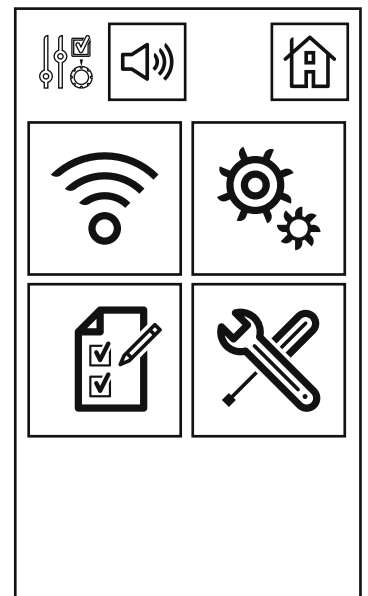

The list here on the side shows different types of adjustments:

- **Oven model.** The user can only visualize some data concerning the typology of the oven (direct steam or with boiler...)
- **Parameters.** The user can modify some parameters.
- **Firmware.** The user, entering this area, can update the firmware in case the manufacturer has issued a new version.
- **Languages.** In this area the user can select one among the available languages.
- **Date and time.** The configuration of date and time are useful for the management of HACCP data synchronization.
- **Recipes.** In this area you can upload or download the automatic stored programs.
- **HACCP.** In this area you can upload on a USB pen drive the stored HACCP data.
- **Reset of factory configuration.** In this area you can re-establish the factory configuration of the oven.

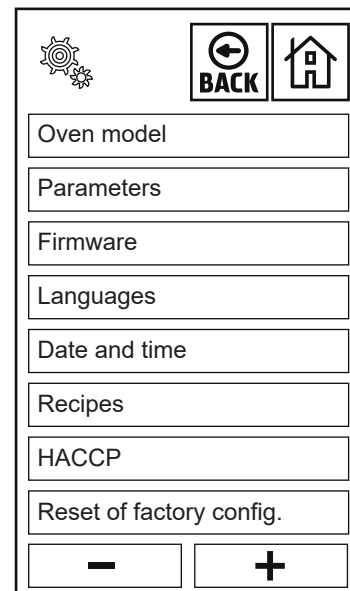

**VERY IMPORTANT: ALL OPERATIONS OF THIS AREA, THAT REQUIRE DATA DOWNLOADING OR UPLOADING, MUST BE EFFECTED CONNECTING A USB PEN DRIVE TO THE SUITABLE CONNECTOR SITUATED IN THE FRONTAL PART OF THE OVEN, BELOW THE CONTROL PANEL.**

If you access the language management, you can select one language among the ones stored or upload a new language (using USB connection) if the manufacturer has implemented this option.



Accessing HACCP area you can download the data stored by the oven.

2 available options are the following:

**HACCP Download & cancel**

In this case the data transferred on the flash drive are removed from the memory of the oven.

**HACCP Download & keep**

In this case the data transferred on the flash drive are also hold in the memory of the oven.

When the memory destined to HACCP data is full, the oven will overwrite the less recent data.

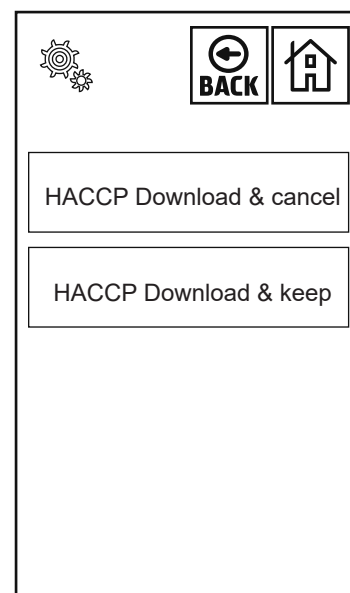



## 9.0 MAINTENANCE

It is compulsory to turn the main switch off and close the water on-off valve, both installed upstream from the oven before servicing it.

The oven should be cleaned at the end of each working day, using specific products only.

All stainless steel parts should be:

- 1 - cleaned with clear, soapy water;
- 2 - rinsed with water;
- 3- dried thoroughly.

It is absolutely forbidden to use scrapers, metal soap pads and other common steel tools as they could besides scratching the surface, deposit iron particles that, oxidizing would cause rust to form.

### **DO NOT WASH THE APPLIANCE WITH JETS OF WATER**

### **DO NOT USE PRODUCTS TO WASH THE STAINLESS STEEL PARTS, WHICH CONTAIN CHLOR (BLEACH, CHLORINE ACID) EVEN IF WATERED DOWN.**

Food and residuals and grease must be removed from the coking chamber each time it is used for cooking.

## 9.1 WHAT TO DO IN CASE OF A BREAKDOWN AND/OR EXTENDED PERIOD OF NON USE

When the appliance is not used for long periods of time :

- 1 - Turn the main switch off
- 2 - Close the water on-off valve (both installed upstream from the oven);
- 3 - Leave the door open so air can circulate and prevent bad odors;
- 4 - With a cloth spread a thin protective layer of Vaseline oil on all stainless steel surfaces;

If the oven does not work properly, breaks down or if the safety thermostat triggers, switch the oven off, disconnect the electricity and water supply and notify the technical assistance service.

**All work of installation, maintenance and repairs should be carried out exclusively by qualified and authorized personnel.**

## 10.0 COOKING TIPS

To obtain the best results, we advise to use **GAS-TRONORM** trays, available in different models and materials according to the type of cooking.

It's fundamental always to **leave an interspace of 3 cm at least** between the food to be cooked and the upper tray for a good air circulation.



The height of the food should be similar to the height of the trays. Very low lays of food in trays of 65 and 80 mm can cook in a non uniform way.

It is advisable to avoid the food to be cooked overflows from the pan , or in case this is not feasible, avoid placing the pan on the top floor to that affected by the situation described.

Cooking of different food can be performed simultaneously at the same temperature , avoiding the overlapping of flavors, placing the products with stronger flavor always on the top of the cooking chamber and the release valve must to be open.

For an optimal cooking temperature you must take into consideration the following rule: select a lower temperature of about 20 % compared to the one set in traditional static ovens without ventilation.

The forced ventilation system, of which this oven is equipped, ensures cooking in reduced time.



**Convection cooking with 0% humidification:** this method, commonly called "Convection", is indicated for all types of cooking where you want to get dry and crispy food.

To achieve this result it is advisable to open the release valve to help the exhaust of steam from the cooking chamber.

**Convection cooking with humidification:** this method, commonly called "combined" is indicated for all types of cooking where you want to get soft and juicy food

**Steam cooking:** with this system, you can achieve cooking very similar to the boiling in water.

Steam with no pressure ensures even and delicate cooking, and food loses almost no vitamins and mineral salts.

Cooking times are much shorter compared to those when water is used.



We always recommend using the perforated G.N. tray so that, when cooking has finished, there is no water on the bottom of the tray.

If you need to use the cooking liquid you can put an ordinary G.N. tray underneath.

## 10.1 REMEDIES TO COOKING HITCHES

### If cooking is uneven:

Check that there is at least 3 cm between the food cooking and the tray above it: if there is less space it will not allow correct ventilation of the food to be cooked.

- Make sure that the foods to cook are not against each other which would prevent correct ventilation between them.
- Cooking temperature might be too high, try with a lower temperature.
- The preheating has not been effected. If you introduce the products with cold cooking chamber, it will take a much longer time to reach the selected temperature than the one requested by preheating. During this phase the ventilation and the temperature inside the cooking chamber could not be uniform and produce therefore a loss of cooking uniformity.
- Frozen food has been introduced in the oven. In this case it's advisable to the food at a temperature of 40-50 °C and then proceed with cooking.
- The oven drain could be obstructed and alter the ventilation inside the cooking chamber.
- The door gasket could not be steam tight. The steam coming out from the door could alter the ventilation.

### If the food is dry:

- Reduce cooking time.
- The temperature must be adequately lowered.
- Remember that the lower the temperature is the less weight will be lost.
- The combined cycle for a humidity rich cooking environment was not selected.
- The food was not greased with oil or juices before it was put in to cook.